



TimeHub 5500

User's Guide
Issue 10 – January 2007
Part Number 097-55501-01

Symmetricom, Inc.
2300 Orchard Parkway
San Jose, CA 95131-1017
U.S.A.

<http://www.symmetricom.com>

Copyright © 1999–2007 Symmetricom, Inc.
All rights reserved. Printed in U.S.A.

All product names, service marks, trademarks, and registered trademarks
used in this document are the property of their respective owners.

Contents

How to Use This Guide

Purpose of This Guide	14
Who Should Read This Guide	14
Structure of This Guide	15
Conventions Used in This Guide	16
Warnings, Cautions, Recommendations, and Notes	17
Related Documents and Information	18
Where to Find Answers to Product and Document Questions.	18
What's New In This Guide	18

Chapter 1 Description

Overview	20
Physical Description	21
Functional Description	21
Communication Ports	23
Power Supply	23
Input/Alarm Connector Module	23
Clock Cards	24
Management Card	24
Output Driver Cards	25
Output Connector Modules	25
Connection Panels	25
Alarms	25
Alarm Connections	26
Synchronization Status Messaging	27
Input SSMs	27
Automatic Reference Switching	28
Output SSMs	28
Passthrough Mode	29
Passthrough Considerations	31
Firmware Versions and Passthrough Operation	31
Master/Remote Shelf	32
Remote Shelf Capability	33
SSMs in a Remote Shelf	34
Expansion Shelf	35
Output Driver Cards	36
Expansion Controller Card	36
Rear Panel of the Expansion Shelf	37
Expansion Output Connector Modules	37
Output Driver Cards and Output Connector Modules	38

Redundancy Considerations 38
 Communicating With the Expansion Shelf 39
 TimeScan THC Software 40

Chapter 2 Engineering & Ordering Information

Overview 42
 Wire-wrap Panels 42
 Accessories 44
 Card Overview 44
 Clock Cards 44
 Management Card 48
 Output Driver Cards 50
 Input/Alarm Connector Module 53
 Output Connector Modules 54
 Expansion Controller Card 56
 Ordering and Parts List 59
 User-Supplied Tools and Materials 62

Chapter 3 Installing the TimeHub

Overview 64
 Site Survey 64
 Preliminary Procedures 64
 Installation Tools and Equipment 65
 Electromagnetic Interference (EMI) Considerations 65
 Ventilation Considerations 66
 Installation Checklist 66
 Unpacking the TimeHub 5500 67
 Rack Mounting the TimeHub 5500 67
 Mounting the Shelf 67
 Installing the Wire-wrap Panel 68
 Configuring the Shelf as a Master or Remote 72
 Making Ground and Power Connections 73
 Grounding the Shelf 73
 Grounding the Wire-wrap Panel 75
 Making Power Connections 75
 Testing Power Connections 76
 Installing Modules into the Rear Panel 77
 Installing Rear Panel Modules 77
 Installing the Input/Alarm Connector Module 78
 Installing Output Connector Modules 78
 Installing Blank Panels 80
 Making Signal Connections 81
 Making Shelf-to-Panel Connections 82

Connecting Timing Inputs	86
Making Communication Connections	88
Connecting Alarms	89
GPS Input	91
Installing the Cover	91
Installing Expansion Shelves	92
Installing the Shelf in the Rack	92
Making Ground and Power Connections.	92
Setting the Expansion Shelf Address	92
Installing Output Connector Modules	94
Making Expansion Shelf Connections.	95
Removing Expansion Shelves	101

Chapter 4 Testing and Configuring the TimeHub

Overview	104
Installing Cards into the Front Panel	104
Installing the Management Card	105
Installing the Clock Cards	108
Confirming the Master or Remote Shelf Setting	110
Installing Output Driver Cards	111
Installing Cards into the Expansion Shelf.	112
Installing Expansion Controller Cards	112
Installing Output Driver Cards	113
Establishing a Connection to the TimeHub	113
Communicating by Serial Port.	114
Communicating by Ethernet	116
Provisioning Master Shelf Parameters.	121
Setting the Date and Time.	122
Setting the System ID	122
Setting the Target ID.	123
Verifying the Hardware Setup	124
Provisioning Inputs on a Master Shelf	125
Testing an Expansion Shelf	132
Provisioning Inputs on a Remote Shelf	136
Testing the Clock Input Signals	140
Provisioning the Outputs	142
Securing Cards in the Shelf.	146
Configuring CC Signals	146
Phase Aligning CC Input and CC Output	147
Setting the Delay on CC Outputs	148
Checking System Operation	150
Enabling Security	151
Managing the User List	153
Setting the Configuration to Factory Defaults	155

Chapter 5 Maintaining the TimeHub 5500

Clearing Output Port Alarms	158
False Reporting of Output Port Alarms	158
Clearing False Port Alarms	159
Testing the Cards	161
Reference Switching	161
Removing a Clock Card	163
Troubleshooting the TimeHub 5500	163
Troubleshooting the Clock Card	164
Troubleshooting the Output Driver Card	172
Reading the Output Driver Firmware Version	175
Troubleshooting the Management Card	177
Troubleshooting the Expansion Controller Card	182
Replacing Cards	185
Replacing the Clock Card	185
Replacing the Output Driver Card	186
Replacing the Management Card	186
Replacing the Expansion Controller Card	187
Replacing Fuses	188
Replacing the Fuse in the Clock Card	188
Replacing the Fuse in the Management Card	189
Replacing the Fuse in the Output Driver Card	190
Replacing the Fuse in the EC Card	191
Upgrading the Software	192
Manually Downloading Software	194
Backing Up the New Software	199
Repairing a Corrupt File System	200
Returning the TimeHub for Repair	201
Repacking the Unit	201
Equipment Return Procedure	202
Contacting Symmetricom Global Services	202
User Manual Updates	203

Chapter 6 Specifications

Overview	206
Local Communication Port	206
LAN Communication Port	206
Remote Communication Port	206
GPS Input	206
Expansion Link 1 Input	207
Expansion Link 2 Input	207
DS1 Inputs	207
PRS Reference Input	208
Composite Clock Inputs	208
DS1 Outputs	208

Composite Clock Outputs	209
Output Alarms	209
Input Alarms	210
Power	210
Shelf Mechanical	210
Wire-wrap Panel Mechanical	211
Shelf and Wire-wrap Panel Environmental	211
Certification	211
Factory Default Values	211
Management Card Default Settings	211
Clock Card Default Settings	212
Output Driver Card Default Settings	213
User Changes to Factory Defaults	214
Index	217

Figures

1-1	The TimeHub 5500.	20
1-2	TimeHub 5500 Shelf and Connection Panels	21
1-3	Block Diagram of the TimeHub 5500	22
1-4	TimeHub 5500 Expansion Shelf – Front View	35
2-1	Front and Rear of the High-Density Wire-wrap Adapter Panel	42
2-2	Front Panel of the ST2-Rb Clock Card	45
2-3	Front Panel of the Management Card	48
2-4	Front Panel of the Output Driver Card	51
2-5	Front Panel of the Input/Alarm Connector Module.	53
2-6	Output Connector Modules for the Master/Remote Shelf: DS1 (left) and CC (right).	55
2-7	Output Connector Modules for the Expansion Shelf: DS1 (left) and CC (right).	56
2-8	Front Panel of the Expansion Controller Card	57
3-1	Mounting Options for the Shelf.	68
3-2	High-Density Wire-wrap Panel (Front and Rear)	69
3-3	Assembling the Rack Extenders for a 23-inch Shelf	69
3-4	Sample Rack Installation of a Master Shelf	70
3-5	Sample Rack Installation of a Master and Expansion Shelf.	71
3-6	Master/Remote Rotary Switch	72
3-7	Connectors on the Rear Panel of the Master Shelf	74
3-8	Wire-wrap Panel Ground Connection	75
3-9	Power and Ground Connections on the Master Shelf	76
3-10	Location of Output Connector Modules on the Rear Panel of the Master/Remote Shelf	78
3-11	Location of Output Connector Modules on the Rear Panel of the Expansion Shelf	80
3-12	Rear Panel Connectors on the Main Shelf.	82
3-13	Connecting Outputs to the High-Density Wire-wrap Panel	83
3-14	Connecting Outputs to Existing Wire-wrap Panels.	84
3-15	Connecting A-D Outputs of the Expansion Shelf to the High-Density Wire-wrap Panel.	85
3-16	Connecting E-H Outputs of the Expansion Shelf to the High-Density Wire-wrap Panel	86
3-17	Input/Alarm Connector Module Connections	87
3-18	Power and Ground Connections on the Expansion Shelf	92
3-19	Address Switch SW1 on the Expansion Shelf	93
3-20	Location of Output Connector Modules on the Rear Panel of the Master/Remote Shelf	94
3-21	Connecting a Single Expansion Shelf	97
3-22	Connecting Multiple Expansion Shelves	98
4-1	Front Panel of the TimeHub 5500 Shelf.	104
4-2	Location of Switch S1 on the Management Card.	106
4-3	Front Panel of the Management Card	107

4-4	Front Panel of the Clock Card	109
4-5	Clock Card Switch S1	110
4-6	The TimeHub TimeScan THC Window in Serial Mode	115
4-7	The TCP/IP Dialog Box	117
4-8	Network Parameters Dialog Box	117
4-9	Set TimeHub Date and Time Window	122
4-10	Set TimeHub System ID Window	123
4-11	Set TimeHub Target ID Window	124
4-12	The TimeScan THC Input Screen	126
4-13	The Remote Input Configuration Window	136
4-14	The Remote Input Configuration Window	137
4-15	Configuring Outputs Using TimeScan THC	142
4-16	DS1 Output Waveforms	144
4-17	CC Output Waveforms	144
4-18	The Configuration Output Tab	149
4-19	Enabling Ports for CC Cable Compensation	149
4-20	The User Administration Dialog Box	153
5-1	The Configuration Output Screen	160
5-2	Attempt to Clear Port Alarm Query Screen	160
5-3	Active DS1 Input Signal Indication	162
5-4	Front Panel of the Clock Card	164
5-5	SNDRIFT Decision Tree.	171
5-6	Front Panel of the Output Driver Card	172
5-7	Front Panel of the Management Card	177
5-8	Front Panel of the Expansion Controller Card	182
5-9	Location of Fuse XF1 on the Clock Card	188
5-10	Location of Fuse F1 on the Management Card and the Output Driver Card	189
5-11	Location of Fuse F1 on the EC Card	191
5-12	The TimeHub WARP Window	193
5-13	The WARP Log Window.	193
5-14	The Windows Run Dialog Box	194
5-15	Example FTP Download Process, Part 1	195
5-16	Example FTP Download Process, Part 2.	197
5-17	Example FTP Download Process, Part 3.	198

Tables

1-1	SSM Quality Level and Meaning	27
1-2	SSM Source Determination for Remote Shelf	34
2-1	Wire-Wrap Panels Available for the TimeHub 5500.	43
2-2	Wire-Wrap Connection Cables.	43
2-3	Cable Management Panels Available for the TimeHub 5500.	43
2-4	Accessories for Adapter Panels	44
2-5	Clock Card Front Panel Indicators	46
2-6	Management Card Front Panel Indicators	49
2-7	Output Driver Card Front Panel Indicators	52
2-8	Expansion Controller Card Front Panel Indicators	58
2-9	Master and Remote Shelf Basic Components	59
2-10	Expansion Shelf Basic Components	60
2-11	Accessories and Spare Parts	61
3-1	Installation Checklist.	66
3-2	Master/Remote Rotary Switch Settings and Functions	73
3-3	LAN Connector Pinouts	88
3-4	Pinout of Local Communications Port	89
3-5	Expansion Shelf Rotary Switch Settings and Functions.	93
4-1	Management Card S1 Switch Settings.	106
4-2	Clock Card S1 Switch Settings.	110
4-3	Communications Port Assignments	113
4-4	Typical Oscilloscope Settings.	141
4-5	User Level and Access	151
4-6	Command Level and Access	151
5-1	Troubleshooting the Clock Card Front Using the LEDs	165
5-2	Troubleshooting the Output Driver Card Using Front Panel LEDs.	173
5-3	Management Card Front Panel Items	178
5-4	Troubleshooting the Expansion Controller Card.	183
5-5	Downloading to the Second Clock Card	199
5-6	Downloading to the IMC Card	199
5-7	Downloading to the Second Clock Card	200
6-1	Management Card Default Settings	211
6-2	Clock Card Default Settings	212
6-3	DS1 and E1 Output Module Default Settings.	213
6-4	User Changes to Factory Default Settings.	214

How to Use This Guide

This section describes the format, layout, and purpose of this guide.

In This Preface

- [Purpose of This Guide](#)
- [Who Should Read This Guide](#)
- [Structure of This Guide](#)
- [Conventions Used in This Guide](#)
- [Warnings, Cautions, Recommendations, and Notes](#)
- [Related Documents and Information](#)
- [Where to Find Answers to Product and Document Questions](#)
- [What's New In This Guide](#)

Purpose of This Guide

The *TimeHub 5500 User's Guide* describes the procedures for unpacking, installing, using, maintaining, and troubleshooting the Symmetricom TimeHub 5500. It also includes appendixes that describe alarms and events, the languages that you use to communicate with the TimeHub 5500, default values, and other information.

Who Should Read This Guide

[Chapter 1, Description](#), is written for non-technical audiences who need general information about the product. [Chapter 2, Engineering & Ordering Information](#), and subsequent chapters contain technical information about the product. Other chapters and appendixes describe installation, maintenance, and configuration instructions or details primarily intended for qualified maintenance personnel.

This *User Guide* is designed for the following categories of users:

- **Systems Engineers** – [Chapter 1](#) provides an introduction to the TimeHub 5500. Cross-references in this chapter direct you to detailed system information in other chapters as appropriate.
- **Installation Engineers** – [Chapter 2](#) through [Chapter 6](#) and the Appendixes provide detailed information and procedures to ensure proper installation, turn-up, operation, configuration, and testing of the TimeHub 5500.
- **Maintenance Engineers** – [Chapter 5](#) and the Appendixes provide preventive and corrective maintenance guidelines, as well as procedures for diagnosing and troubleshooting fault indications and alarms.

While [Chapter 1](#) is written for non-technical audiences who need information about the TimeHub 5500 system, others, such as [Chapter 2](#) through [Chapter 6](#) contain detailed information and instructions which are intended to be performed by *qualified personnel only*.

Structure of This Guide

This guide contains the following sections and appendixes:

Chapter, Title	Description
Chapter 1, Description	Provides an overview of the product, describes the major hardware and software features, and lists the system specifications.
Chapter 2, Engineering & Ordering Information	Describes the modules and cards available with the TimeHub 5500 and provides the part numbers for the parts and accessories.
Chapter 3, Installing the TimeHub	Contains procedures for unpacking and installing the product, and for powering up the unit.
Chapter 4, Testing and Configuring the TimeHub	Provides checklist-based commissioning tests that should be performed after completing turn-up and software configuration to ensure the system is ready for normal operation. Describes the ICS and TL1 commands required to provision the TimeHub 5500 after installing the unit.
Chapter 5, Maintaining the TimeHub 5500	Contains preventive and corrective maintenance, and troubleshooting procedures for the product.
Chapter 6, Specifications	Lists the specifications for the TimeHub 5500.
Index	Provides references to individual topics within this guide.

Conventions Used in This Guide

This guide uses the following conventions:

- **Acronyms and Abbreviations** – Terms are spelled out the first time they appear in text. Thereafter, only the acronym or abbreviation is used.
- **Revision Control** – The title page lists the printing date and versions of the product this guide describes.
- **Typographical Conventions** – This guide uses the typographical conventions described in the table below.

When text appears this way...	... it means:
TimeHub 5500 User's Guide	The title of a document.
SSU CRITICAL IOC1	An operating mode, alarm state, status, or chassis label.
Select File , Open ...	Click the Open option on the File menu.
Press Enter Press ;	A named keyboard key. The key name is shown as it appears on the keyboard. An explanation of the key's acronym or function immediately follows the first reference to the key, if required.
SSU Username :	Text in a source file or a system prompt or other text that appears on a screen.
PING STATUS	A command you enter at a system prompt or text you enter in response to a program prompt. You must enter commands for case-sensitive operating systems exactly as shown.
A <i>re-timing</i> application	A word or term being emphasized.
Symmetricon does not recommend...	A word or term given special emphasis.

Warnings, Cautions, Recommendations, and Notes

Warnings, Cautions, Recommendations, and Notes attract attention to essential or critical information in this guide. The types of information included in each are explained in the following examples.



Warning: To avoid serious personal injury or death, *do not* disregard warnings. All warnings use this symbol. Warnings are installation, operation, or maintenance procedures, practices, or statements, that if not strictly observed, may result in serious personal injury or even death.



Caution: To avoid personal injury, *do not* disregard cautions. All cautions use this symbol. Cautions are installation, operation, or maintenance procedures, practices, conditions, or statements, that if not strictly observed, may result in damage to, or destruction of, the equipment. Cautions are also used to indicate a long-term health hazard.



ESD Caution: To avoid personal injury and electrostatic discharge (ESD) damage to equipment, *do not* disregard ESD cautions. All ESD cautions use this symbol. ESD cautions are installation, operation, or maintenance procedures, practices, conditions, or statements that if not strictly observed, may result in possible personal injury, electrostatic discharge damage to, or destruction of, static-sensitive components of the equipment.



Electrical Shock Caution: To avoid electrical shock and possible personal injury, do not disregard electrical shock cautions. All electrical shock cautions use this symbol. Electrical shock cautions are practices, procedures, or statements, that if not strictly observed, may result in possible personal injury, electrical shock damage to, or destruction of components of the equipment.



Recommendation: All recommendations use this symbol. Recommendations indicate manufacturer-tested methods or known functionality. Recommendations contain installation, operation, or maintenance procedures, practices, conditions, or statements, that provide important information for optimum performance results.



Note: All notes use this symbol. Notes contain installation, operation, or maintenance procedures, practices, conditions, or statements, that alert you to important information, which may make your task easier or increase your understanding.

Related Documents and Information

Other helpful documents and software tools are listed below. See your Symmetricom representative or sales office for a complete list of available documentation.

- *TimeHub 5500 TL1 Reference Guide* 097-55501-01
- TimeScan THC management software



Note: Symmetricom offers training courses designed to enhance your knowledge of the TimeHub 5500. Contact your local representative or sales office for a complete list of courses and outlines.

Where to Find Answers to Product and Document Questions

For additional information about the products described in this guide, please contact your Symmetricom representative or your local sales office. You can also contact us on the web at www.symmetricom.com.

What's New In This Guide

Issue 10 of this guide contains the following new information:

- Added [Verifying the Installation](#), on page 99
- Added [Removing Expansion Shelves](#), on page 101
- Added [Testing an Expansion Shelf](#), on page 132
- Added [SNDRIFT Events](#), on page 169
- Revised [Upgrading the Software](#), on page 192, to account for new memory chips in the CPU card
- Revised [Manually Downloading Software](#), on page 194, to account for new memory chips in the CPU card
- Revised [Repairing a Corrupt File System](#), on page 200, to account for new memory chips in the CPU card

Chapter 1 Description

This chapter describes the TimeHub 5500, and includes the following topics:

- [Overview](#)
- [Physical Description](#)
- [Functional Description](#)
- [Alarms](#)
- [Synchronization Status Messaging](#)
- [Passthrough Mode](#)
- [Master/Remote Shelf](#)
- [Expansion Shelf](#)
- [TimeScan THC Software](#)

Overview

The TimeHub 5500, shown in [Figure 1-1](#), is a building integrated timing supply (BITS) redundant timing distribution system for 1.544 Mb/s primary rate networks. The system tracks incoming timing references, qualifies the signals against network timing standards, then filters and distributes up to 140 precise timing signals.

The TimeHub 5500 clock uses precision timing references such as Primary Reference Clocks (PRCs) (cesium frequency standards), GPS Primary Reference Source (PRS) receivers, and DS1 input references from other nodes to generate synchronized composite clock (CC) (64 kb/s) and DS1 (1.544 Mb/s) timing output signals. These signals provide timing synchronization inputs to various network elements. If a reference input is lost, the TimeHub 5500 provides SmartClock holdover that exceeds Stratum 2 accuracy.

TimeHub 5500 applications include providing timing synchronization for ATM, SONET, and digital wireless networks.

The TimeHub 5500 supports up to four optional Expansion shelves. Each Expansion shelf provides up to 320 additional output signals, for a maximum of 1420 outputs in a full system.



Figure 1-1. The TimeHub 5500

Physical Description

The TimeHub 5500 consists of a shelf, wire-wrap panel(s), plug-in cards, connector modules, cables, hardware, and software. As an option, you can install Clock cards with four additional DS1 inputs for a total of nine inputs. The shelf contains slots for a Management card, two Clock cards, and up to eight Output Driver cards.

The shelf and the connection panel(s) can be mounted in a 19-inch or a 23-inch rack, as shown in [Figure 1-2](#). All connectors are at the rear of the shelf and connection panel(s), except for a communications connector on the Management card.

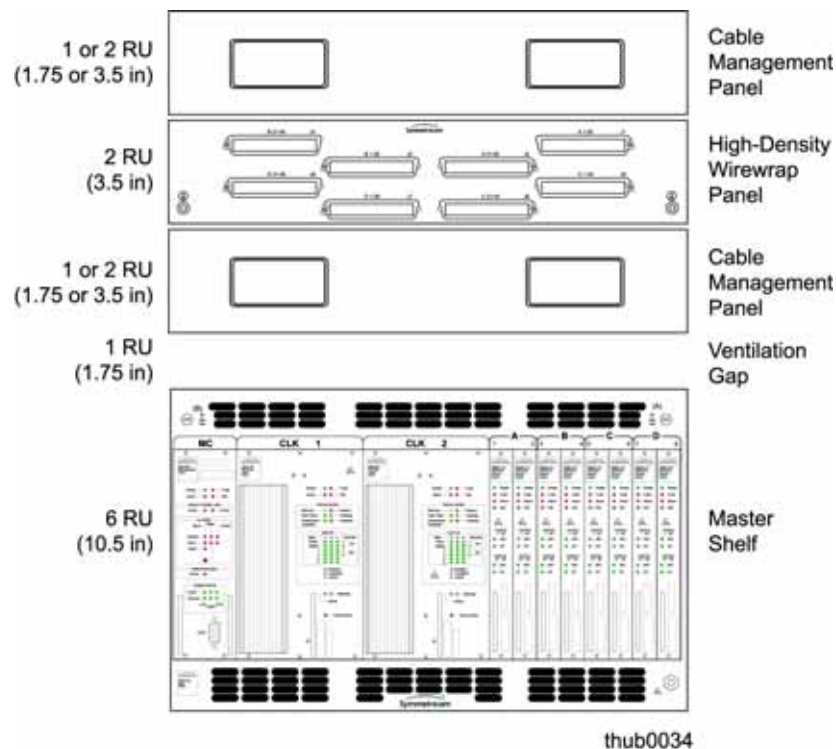
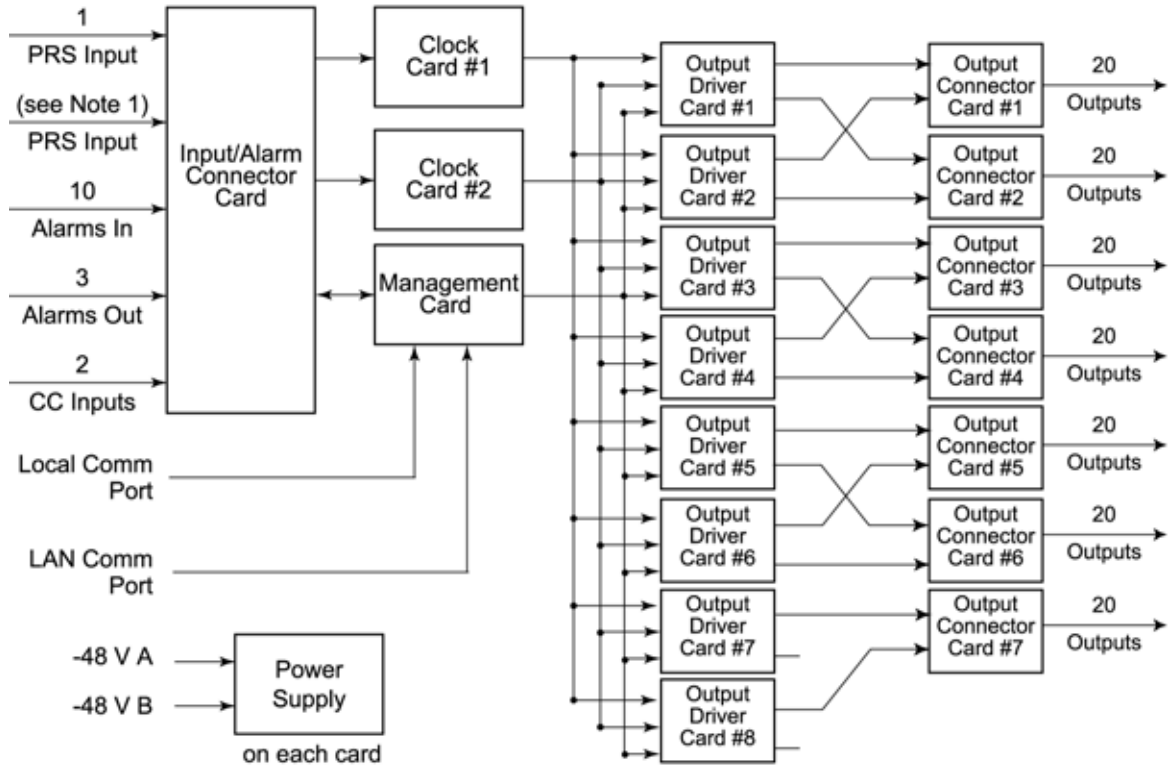

Figure 1-2. TimeHub 5500 Shelf and Connection Panels

Functional Description

The TimeHub 5500 accepts up to five incoming signals and selects one of the qualified references (inputs 0–4) as the active tracked reference using criteria programmed by a system administrator. The TimeHub 5500 then filters and distributes precise timing signals to the office equipment. Inputs 5–8 on an optional Clock card can be monitored for performance but none can be selected as the active reference that drives the outputs.

Figure 1-3 shows a block diagram of a TimeHub 5500 with redundant Clock cards and 140 protected outputs. The outputs of each Clock card and the Management card are connected to all Output Driver cards. Expansion shelves are capable of providing 320 protected outputs.



Note 1: 4 DS1 reference inputs or 4 DS1 reference inputs and 4 DS1 monitor signals.

thub0003

Figure 1-3. Block Diagram of the TimeHub 5500

If all reference inputs fail, the system continues to provide timing by using its own internal reference as a source (holdover).

If both Clock cards are removed, the Management card provides an unfiltered version of an input to the output cards (passthrough) when the input levels are sufficient. This feature is available on Master or Remote Master shelves with Clock and IMC cards equipped with hardware version "B" or higher and firmware version R4315C or higher. For more information on passthrough, see [Passthrough Mode](#), on page 29.

Communication Ports

LAN

The LAN connection allows you to connect the TimeHub 5500 to an Ethernet network for monitoring and provisioning. You configure network parameters using TL1 commands. The TimeHub 5500 can support up to 10 simultaneous network sessions. The TL1 commands are described in detail in the *TL1 Reference Guide*.

Local

There are two Local port connections: one on the rear panel of the shelf and one on the Management card. Dual connections are provided for access convenience and both are physically connected to the same serial port. These ports provide a means for TL1 command access to the TimeHub 5500.



Note: Communication cannot be established to both of the Local ports simultaneously; only one port can be used at a time.

Power Supply

Each card is provided with its individual power supply unit. Two external power inputs supply the voltage to each card on the shelf.

Input/Alarm Connector Module

The Input/Alarm Connector module provides the connections for input reference signals to the shelf and for the alarm outputs. There are five timing inputs: one PRS input and four DS1 inputs. The PRS input can be either 5 MHz or 10 MHz. Depending on the type of Clock card used, four additional DS1 timing inputs can be used for monitoring only.

DS1 inputs 1–4 can be used as a reference or for monitoring. (DS1 inputs 5–8 can only be monitored.) If used as a reference, the input may be used for tracking and can cause events or alarms if not qualified. Performance monitoring is also available for inputs used as references. If monitored only, the input is monitored without being used for tracking and no alarms occur, but the signal status is reported via the TL1 interface.

You make the alarm connections on the Input/Alarm Connector module as described in [Alarm Connections](#), on page 26.

Clock Cards

Clock cards provide input monitoring, selection, and holdover. Two types of Clock cards are available for the TimeHub 5500:

- Standard Clock cards: These cards are equipped with five inputs (four DS1 and one 5/10 MHz) and *do not* support Expansion shelves.
 - Five-input with an ST2E rubidium oscillator (090-55513-01)
 - Five-input with an ST3E quartz oscillator (090-55511-01)
- Extended-capacity Clock cards: These cards are equipped with nine inputs (four DS1, four monitoring inputs, and one 5/10 MHz) and support Expansion shelves. If you plan to use an Expansion shelf (or shelves) attached to a Master shelf, you *must* use extended-capacity Clock cards.
 - Nine-input with an ST2E rubidium oscillator (090-55514-02)
 - Nine-input with an ST3E quartz oscillator (090-55512-02)

Two Clock cards are required for redundancy; oscillator types can be mixed.

Each Clock card receives the input reference signals from the Input/Alarm Connector card, determines their quality for use by the system, and selects the most appropriate input signal to use as the active reference. During normal operation, the active clock tracks the active input signal, and produces a precise frequency for the Output Driver cards based on the input reference. The standby clock does the same thing except its output is not used by the Output Driver cards. The standby clock backs up the active clock, ready to become active when necessary.

If the input reference is disqualified, the Clock card selects another qualified input signal as the reference. If no input references are qualified, the Clock card goes into holdover, using its own oscillator as the system reference.

For detailed information on Clock cards, see [Clock Cards](#), on page 44.

Management Card

The Management card manages alarms to and from the TimeHub 5500, and provides local and Ethernet LAN communication interfaces. The TimeHub 5500 can operate without a Management card installed, but you will lose any communications abilities, alarms, and the Passthrough feature.

If an alarm condition occurs, the Management card determines whether the alarm state is critical, major, or minor, actuates the corresponding alarm relays, causes the appropriate LEDs to light, and generates TL1 alarm message(s) via the local or LAN communication interface. For more detailed information on the Management card, see [Management Card](#), on page 48.

Output Driver Cards

Output Driver cards provide non-protected or protected DS1 or CC outputs. A single Output Driver card provides 40 non-protected outputs. Two Output Driver cards functioning as a pair provide 40 protected outputs. An Output Driver card can provide either 20 DS1 and 20 CC outputs or 40 of either type. The Output Connector modules installed on the rear panel of the shelf determine the type of output signal. [Output Driver Cards](#), on page 50, describes the Output Driver cards in more detail.

Specific capabilities of the Output Driver card include:

- Drive up to 40 outputs (40 DS1, 40 CC, or 20 CC and 20 DS1)
- DS1 framable D4 or ESF, with full SSM support for ESF
- Selective enable for every port
- Controllable CC cable delay compensation. Each port can have delay compensation enabled or not. Each group of 20 ports (1-20 and 21-40) can have a specific delay amount applied.

Output Connector Modules

There are two types of Output Connector modules: DS1 and CC Output Connector modules. Each module contains the hardware required to interface with the output type (DS1 or CC). The Output Driver card reads the Output Connector module to determine the appropriate voltage levels, frequency, and format for the corresponding output type. See [Output Connector Modules](#), on page 54, for more information on Output Connector modules.

Connection Panels

Timing output connections between the TimeHub 5500 and network elements are made at the wire-wrap connection panel. Each high-density wire-wrap connection panel can accommodate up to 160 outputs.

Alarms

Alarms are indicated by shelf and card status LEDs, and TL1 messages are reported via the local or LAN communication interface. In addition, contact closures provide for remote indication of alarms on the shelf.

There are two types of alarms associated with the TimeHub 5500: shelf and system. A shelf alarm is one that occurs from within the TimeHub 5500 shelf, and a system alarm is one that is sensed via one of the external alarm wire-wrap inputs on the input/ alarm card. If an alarm is sensed on any of these 10 external alarm inputs, it appears as a "System" alarm on the Management card front panel.

If simultaneous alarms occur with different severity levels, the front panel LEDs indicate only the one with the highest severity. For example, if both MAJOR and MINOR shelf alarms are present, only the MAJOR alarm LED is lit in the “Shelf” alarm row. In this case, if the MAJOR alarm ends, then the MINOR alarm LED lights (assuming that the source of that alarm is still present) since this is now the highest severity shelf alarm.

If there is a MAJOR *shelf* alarm and a MINOR *system* alarm (any of the external alarms in 7 to 10 range) then the MAJOR LED is lit for the shelf alarm row and the MINOR LED is lit for the system alarm row. In other words, it is possible to have alarm LEDs of different severity illuminated if one is a shelf alarm and the other a system alarm.

In all cases, all current alarms are reported via the TL1 command interfaces (serial and network) and can be retrieved at any time using the RTRV-ALM query (see the *TL1 Reference Guide*). If there are multiple alarms of the same and different severity, all are included in the RTRV-ALM response.

Alarm Connections

You make all alarm connections on the Input/Alarm Connector module at the rear panel of the shelf.

Contact Closure Inputs

Ten sets of contact closure inputs are provided to connect to relay outputs of equipment external to the shelf. Four of these input sets are Universal, and six are contact closure only.

Contact Closure Outputs

Contact closure outputs are provided to actuate visible and/or audible alarm indicators to inform the office of an alarm condition within the shelf.



Note: Contact closure outputs are generated by the Management card. The Management card must be installed in order to generate contact closure alarms or TL1 messages.

There are two sets of wire-wrap pins for Audible and Visual alarms; each set allows you to make connections for Minor, Major, and Critical alarms. For more information on the Input Connector card, see [Installing the Input/Alarm Connector Module](#), on page 78.

Synchronization Status Messaging

The TimeHub 5500 supports input and output SSM (Synchronization Status Messaging). SSM provides a method for providing clock quality information to any equipment that uses synchronization inputs. For DS1 signals, SSM information can be encoded on ESF (Extended Super Frame) signals. D4 (also known as SF) DS1 signals are not capable of transporting SSM. You can use SSMs to automatically switch the input reference to the next-best available signal if the current input reference becomes unavailable.

The relationship between SSM quality level and the meaning attached to each level is listed in [Table 1-1](#).

Table 1-1. SSM Quality Level and Meaning

Description	Quality Level	Abbreviation
Stratum 1 Traceable	1	PRS
Synchronized – Traceability Unknown	2	STU
Stratum 2 Traceable	3	ST2
Transit Node Traceable	4	TNC
Stratum 3E Traceable	5	ST3E
Stratum 3 Traceable	6	ST3
SONET Minimum Clock Traceable (20 ppm clock)	7	SMC
Stratum 4 Traceable	8	ST4
DO NOT USE for synchronization	9	DUS
Reserved	10	RES

Input SSMs

The TimeHub 5500 provides several input-related SSM capabilities. You can provision the TimeHub 5500 to read the SSM value associated with any input. You can then use that value to determine which input becomes the active reference signal. If an input does not have an SSM value associated with it (such as a D4-framed DS1 input or a 5/10 MHz input), you can assign an SSM value to the input.

The TimeHub 5500 can extract and report the encoded SSM value on any of the timing inputs using the TL1 keyword CURRSSM. This keyword allows you to retrieve the SSM value currently associated with a selected input. The value returned is the Quality Level in [Table 1-1](#). For detailed syntax, see the description of this keyword in the TimeHub 5500 *TL1 Reference Manual*.

If the input does not support SSMs (for example, D4 framed DS1 and 5/10 MHz inputs), you can assign an assumed SSM value to the input using the TL1 keyword QLEVEL. Assigning an SSM allows an input to be automatically selected when the synchronization mode is set to SSM.

Automatic Reference Switching

You can use the SSM values on the input signal to determine which input is selected as the active timing reference. The TL1 keyword SYNCMDE provides this control. SSM is one of the four possible SYNCMODE setting; when SSM is selected, the CURRSSM value is the primary factor for selecting which input becomes the active reference (the input must be otherwise qualified for use to be selected). For more details on setting the sync mode, see [Provisioning Inputs on a Master Shelf](#), on page 125.

Three factors determine how the TimeHub 5500 selects the active timing reference from the available qualified input signals:

1. Quality Level, which is either read directly from the SSM on the input signal, or is assigned using the TL1 keyword QLEVEL. There is no preference given to an input that is actually extracting SSM values (requires enabling SSMENB) compared with one that is using an assumed SSM quality level (SSMENB disabled).
2. SSM Priority level, which you assign to each input using the TL1 keyword SSMPRI. For information on using these keywords and the syntax, see the *TL1 Reference Guide*.
3. The location of the reference signal on the Input panel; inputs on lower-numbered inputs have higher priority when the other two factors have the same value.

If the CURRSSM quality value for an otherwise qualified input is numerically higher than the quality level of the internal reference oscillator in the Clock card, that input will be disqualified and hence cannot be selected as the active timing reference. The rationale for this is that the internal reference oscillator will provide a better timing reference than any input with a lower quality level. The quality levels for TimeHub 5500 internal oscillators are 3 for any rubidium type clock (090-55513-01 and 090-55514-02) (Stratum 2 traceable) and 5 for any quartz type clock (090-55511-01 and 090-55512-02) (Stratum 3E traceable). The QCUTOFF keyword can be used to set an additional quality value that will disqualify any input whose CURRSSM value is higher than the selected QCUTOFF value.

Output SSMs

SSMs are automatically encoded onto any DS1 output set for ESF framing. Normal operation automatically encodes an appropriate SSM quality level on such outputs; you can override the automatic setting and manually set the quality level to be encoded on DS1 ESF outputs. Here are some details regarding how the SSM quality level is set for ESF outputs:

During normal operation, where a qualified input is being used as the active timing reference, the SSM quality level of that input is included on all DS1 ESF outputs. This quality level can be read by retrieving the CURRSSM value for the currently active timing reference. If the active reference changes to a different input, the SSM output changes to that of the newly selected input. Note that the SSM value is output on DS1 ESF outputs regardless of the selected synchronization mode (see SYNCMDE discussion above). It isn't necessary for SYNCMDE to be set to "SSM" for outputs to encode SSM information.

When the TimeHub 5500 is using an internal oscillator as the timing reference source, the output SSM quality level is the quality level associated with the performance level for that internal oscillator. For the rubidium clocks (090-55513-01 and 090-55514-02) (Stratum 2 traceable), the quality level is 3. For the quartz clocks (090-55511-01 and 090-55512-02) (Stratum 3E traceable), the quality level is 5.

The TimeHub 5500 uses the quality level associated with the Clock card in the following situations:

- After warming up, the Clock card enters the Freerun mode (indicated by an LED on the front panel) while input references are being qualified. During this time the internal oscillator on the active Clock card is the active timing reference.
- If for some reason all external timing references become disqualified (for example, signal is lost), the TimeHub 5500 enters either Freerun or Holdover mode (indicated by an LED on the front panel). In either mode, the active Clock card becomes the active timing reference. If external timing references later become re-qualified, the TimeHub 5500 returns to normal operation and the output SSM quality level changes to match that of the selected input.

You can manually set the output SSM quality level on DS1 ESF outputs using the OMANSSM (Output Manual SSM) keyword. This allows you to select a specific SSM quality level to be output on all channels in an Output card. By enabling OMANSSM (set to "Y") for a particular output card, any DS1 ESF outputs associated with that card outputs the quality level set via the OQLEVEL (Output Quality Level) keyword. A primary reason for providing this capability is to allow information such as "DON'T USE for synchronization" (quality level 9) to be sent to downstream equipment during maintenance operations. Using a signal marked DUS for timing purposes is a violation of the BITS concept and Telcordia general requirements.

Passthrough Mode

The TimeHub 5500 can provide a usable clock in a situation where both Clock cards are removed from the shelf and a usable input signal is present. The capability is called Passthrough and resides on the TimeHub 5500 Management card. The Management card has a connection to the timing inputs, which it continually monitors for signal presence. An LED on the Management card indicates when the Passthrough mode is active. An automatic TL1 message is also provided on both communication ports whenever Passthrough operation begins or ends.

Passthrough is available only when a Clock card has qualified at least one input since power was applied to the Management card. The Management card monitors the Clock cards for qualified inputs; if no qualified input has been detected, or if the signal is not above a minimum level, Passthrough will not enable upon removal of Clock cards. When the Management card has determined that Passthrough is ready, an automatic message, PTAVAIL, is issued. You can remotely check if Passthrough is available by using the TL1 keyword RTRV-COND. See the *TL1 Reference Guide* for more information.

When Passthrough mode is activated, the following hierarchy determines which input is selected as the reference:

- The first choice is the most recently selected input reference prior to removal of the Clock card.
- If the first choice is not available (due to loss of signal), Passthrough is then selected from the inputs previously qualified by the Clock card prior to its removal. The attempt begins with the lowest numbered input.
- If no recently qualified input is available, Passthrough is selected from any other input that is providing a signal. The selection attempt starts with the lowest numbered input.

For example, if inputs 1, 3, and 4 had been qualified by the active Clock card and input 3 was the active reference just prior to removal of the Clock card:

- Input 3 is the first choice; if it is not providing a signal, then
- Input 1 is the next choice since it had been qualified by the clock and it is the lowest numbered such input. If it is not providing a signal, then
- Input 4 is the next choice since it had been qualified and is the next lowest numbered such input. If Input 4 was selected and it goes away, Passthrough cycles through the set of previously qualified inputs, in case one has returned.
- If none of the qualified inputs are available, Passthrough searches the remaining inputs for a signal. In this example, the only remaining inputs are 0 (the 5/10 MHz input) and 2 (DS1 input). Starting with 0, if an input is detected, it is selected as the active reference.

If no timing input is providing a signal while in Passthrough, the outputs are disabled and Passthrough mode ends. Unlike Clock cards, which have the ability to provide holdover capability when all timing inputs are removed (and thus maintain output timing), the Management card cannot provide holdover. Therefore, outputs are disabled if there is no timing input when in Passthrough mode.

Passthrough Considerations

There are several restrictions and special considerations that apply to Passthrough operation:

- Brief phase hits on the outputs are likely when entering and exiting Passthrough mode
- You cannot configure the Clock or outputs while in Passthrough mode
- Passthrough does not have the capability to reject inputs with excessive jitter or that are significantly off frequency.
- Passthrough does not filter input-to-output in the same way as a Clock card, so out-of-mask timing (for example, TDEV and MTIE) is possible.

Firmware Versions and Passthrough Operation

Details of the Passthrough capability depend upon the firmware and hardware versions of the Management (090-55542-01), Clock (090-5551x-xx), and Expansion Controller (090-55545-01) cards. See the note at end of this section for how to check firmware and hardware versions.

If either the Management or Clock cards contain firmware prior to 4315B or have hardware version A, then the passthrough capability is as follows:

- Passthrough functions only if the shelf is configured as a master system. Passthrough will not function if the shelf is configured as a remote system.
- There are likely to be brief phase-hits on the outputs when entering and exiting Passthrough mode.
- If an Expansion shelf is connected to the Master it also will operate in Passthrough mode.

If the Management and Clock cards contain firmware version 4315B or later AND have hardware revision B or later, then the Passthrough capability is as follows:

- Passthrough functions when the shelf is configured as either master or remote. As should be expected, for a remote shelf the timing references must be CC1 inputs. For a master shelf the timing references must be DS1 or 5/10 MHz inputs.
- Phase-alignment between input and output is maintained during the transition into Passthrough from normal operation, while in Passthrough, and during the exit from Passthrough back to normal operation.

While this feature applies to both Master and Remote shelves, the easiest way to understand it is to consider a Remote shelf that is timing a CC input prior to entering Passthrough mode. Prior to Passthrough mode, the alignment of the active CC input and any output CC will be nearly perfect. If you observed the positive bi-polar violations on the input and any CC output on an oscilloscope, you would see that they are completely aligned. The Passthrough feature maintains this alignment while entering into Passthrough, while in Passthrough, and when exiting from Passthrough back to normal operation (which would occur when a Clock card is re-inserted). Thus, the phase alignment between input and output is never lost during the entire Passthrough episode.

If an Expansion shelf is connected, it also operates in Passthrough mode, but its behavior depends on the firmware revision of the Expansion Controller cards:

- If an Expansion Controller card contains version A firmware, outputs from that Expansion shelf do not maintain the pre-Passthrough phase-alignment while in Passthrough mode of operation.
- If an Expansion Controller card contains version B (or later) firmware, outputs from that Expansion shelf *will* maintain pre-Passthrough phase-alignment while in Passthrough mode of operation.



Note: Since Passthrough is not a normal operating mode, it should not be routinely used. It is intended to provide a mechanism to “keep alive” the outputs in a situation when both Clock cards are inadvertently removed. The timing performance when in Passthrough mode cannot be assured.

Master/Remote Shelf

The TimeHub 5500 can be configured for use as a Master shelf or as a Remote shelf. The essential difference between these configurations is that a Master shelf accepts PRS (5 or 10 MHz) and DS1 inputs as timing references while a Remote shelf accepts Composite Clock (CC) inputs as the timing reference(s). Typically, a Remote shelf takes its CC timing inputs from a TimeHub 5500 or DCD master shelf, both which are capable of providing CC outputs.

The Remote shelf provides the same output distribution capability that is provided by a Master shelf. The Passthrough capability is available in the Remote shelf with R4315B or later firmware.

For information on configuring a shelf as a Master or Remote, see [Configuring the Shelf as a Master or Remote](#), on page 72.

Remote Shelf Capability

The TimeHub 5500 Remote shelf can be located up to 3000 feet (1093 m) from the Master shelf that provides the CC timing inputs. The Clock cards in the Remote shelf closely follow the input CC signals; this maintains phase alignment between the CC inputs and CC outputs. Unlike a Master shelf, which provides significant filtering of the input timing references (PRS or DS1 signals), the Remote shelf adjusts its outputs very quickly as changes occur on the CC inputs. Since the input CCs are being distributed from a Master shelf that has already performed the desired filtering on its inputs, only small timing variations are expected at the Remote shelf inputs.

The Remote shelf does not provide performance monitoring data, which is available for the PRS and all DS1 inputs on a Master shelf. For more information on performance monitoring, see the TimeHub 5500 *TL1 Reference Guide* (097-55501-02).

In addition to accepting up to two CC signals as timing references, the Remote shelf can accept up to two DS1 inputs which are used to extract SSM information only.



Note: The DS1 lines extract only the SSM messages and do not extract synchronization signals.

A typical setup for a Master/Remote shelf combination includes:

- Two CC outputs are taken from a Master shelf connected as CC inputs to the Remote shelf. Two outputs are used for redundancy; to isolate the signal paths as much as possible, you can take each CC signal from a different output group on the Master shelf (for example, one from the “C” group and another from the “D” group). You compensate for the delay due to the cable length from the Master shelf using the CCDEL and CCDENB keywords. The preferred method is to compensate for the delay at the Master shelf.
- Two ESF-framed DS1 outputs from different output groups on the Master shelf are connected to the first two DS1 inputs on the Remote shelf. This provides a redundant method for the remote shelf to receive SSM information from the Master shelf.

Operational Specifics

This section describes the capabilities of the Remote shelf that are not available on a Master shelf. The TimeHub 5500 Clock cards are designed to operate in either a Master or Remote shelf configuration. When configured for Remote operation, the Input LEDs on the front panel of the Clock card display information for the inputs. See [Figure 2-2](#), which shows the front panel of the Clock card. The relevant LEDs are CC 1 and 2 and DS1 1 and 2.

CC Timing Inputs

Timing references for the Remote shelf are connected at the Input/Alarm Connector module, located on the rear panel of the shelf (refer to [Figure 3-17](#)). This module supports both Master and Remote operation. For Remote operation, the available timing inputs are labeled CC IN 1 and CC IN 2. Typically a TimeHub 5500 or DCD master shelf provides these signals.

DS1 SSM Inputs

Composite Clock input signals do not provide SSM information that can be included on Remote output signals. You can connect ESF-framed DS1 inputs to a Remote shelf in order to receive encoded SSM information from the Master shelf. The Remote shelf then passes the SSM information on to the outputs. The sole function of these DS1 inputs is for SSM decoding; they are *not* used as timing references.

SSMs in a Remote Shelf

[Table 1-2](#) describes how the source of SSM is determined in a Remote shelf for a variety of conditions. Other than the special case where the OMANSSM keyword is used to manually set the output SSM value (see TimeHub 5500 *TL1 Reference Guide* for details), the SSM source determines the SSM that is encoded on each ESF-framed DS1 output generated on the Remote shelf.

Table 1-2. SSM Source Determination for Remote Shelf

Condition	SSM Source
Shelf has no active timing reference ("A" is not lit in either CC1 or CC2 row).	The SSM value is that of the internal oscillator in the active Clock card (see HFQLEVEL keyword in the <i>TL1 Reference Guide</i>).
Shelf has at least one active timing reference ("A" is lit in either CC1 or CC2 row).	The SSM value is taken from the "assumed" SSM value (see QLEVEL keyword in the <i>TL1 Reference Guide</i>) associated with the active timing reference. For example, if CC2 is the active timing reference, the SSM is taken from QLEVEL setting for channel 11 (Channel 11 is the TL1 reference to CC2).
There are no valid SSM inputs. (No signal/or non-decodable signal connected to DS1-1 and DS1-2) OR neither SSM input is enabled ("E" LED not lit in both DS1-1 and DS1-2 rows).	
Shelf has at least one active timing reference ("A" is lit in either CC1 or CC2 row)	The SSM value is being decoded from the DS1 input that is showing "E", "Q", and "A".
There is a single valid SSM input ("E", "Q", and "A" lit on one DS1 input, Q is not lit on the other one)	
Shelf has at least one active timing reference ("A" is lit in either CC1 or CC2 row)	The SSM value is taken from the DS1 input that has the higher PRIORITY (lower numerical value) setting. This is the one that has "A" lit. See the <i>TL1 Reference Guide</i> for details on PRIORITY keyword.
Both DS1-1 and DS1-2 are decoding valid SSM information ("E" and "Q" are lit for both DS1-1 and DS1-2 rows). Only one of these rows can indicate "A".	

Expansion Shelf

For situations requiring more outputs than can be provided by a Master shelf, the TimeHub 5500 supports one to four Expansion shelves. Each Expansion shelf provides up to 320 protected inputs; using four expansion shelves, a TimeHub 5500 system can provide a total of 1420 outputs.



Note: In order to support Expansion shelves, the Master shelf must be equipped with Extended-Capacity Clock cards, as described in [Clock Cards](#), on page 24. Standard Clock cards do not support Expansion shelves.

[Figure 1-4](#) illustrates the Expansion shelf. There are two types of plug-in cards used with an Expansion shelf: Output Driver cards (p/n 090-55581-01) and Expansion Controller cards (p/n 090-55545-01). Two types of Output Connector modules provide DS1 or CC outputs.



Figure 1-4. TimeHub 5500 Expansion Shelf – Front View

Output Driver Cards

The Expansion shelf uses the same Output Driver cards used on the Master shelf (see the following Note). Each Output Driver card provides 40 outputs, which can be provisioned as all DS1, all Composite Clock (CC), or 20 outputs of each type. The front-panel LEDs indicate the actual provisioning. The Output Connector modules installed on the rear panel of the Expansion shelf determine the type of output signal.

The Output Driver cards are paired to provide a redundant protection scheme. The cards work together such that if either card experiences a failure the output integrity is maintained. When cards are paired, inserting or removing either card has negligible impact on output timing or signal integrity. The Expansion shelf supports 16 Output Driver cards, arranged in groups labeled “A”, “B”, ..., “H”.



Note: Output Driver cards (p/n 090-55581-01) with firmware version R4114C do not function properly in Expansion shelf slot 16H (the output card slot farthest to the right). Output Driver cards with this firmware version function properly in every other output card slot in the Expansion shelf.

Inserting an Output Driver card having this firmware version in slot 16H does not affect service but the card will continually reset itself and not become operational.

A firmware upgrade is available to allow such Output Driver cards to become usable in slot 16H. Contact Symmetricom Global Services (SGS) for details. Output Driver cards with firmware revision 4209A and higher function properly in every slot in the Expansion shelf.

Specific capabilities of the Output Driver card include:

- Drive up to 40 outputs (40 DS1, 40 CC, or 20 CC and 20 DS1)
- DS1 framable D4 or ESF, with full SSM support for ESF
- Selective enable for every port
- Controllable CC cable delay compensation. Each port can have delay compensation enabled or not. Each group of 20 ports (1-20 and 21-40) can have a specific delay amount applied.

For more detailed information on the Output Driver cards, see [Output Driver Cards](#), on page 50.

Expansion Controller Card

The Expansion Controller card (090-55545-01) is used only in an Expansion shelf. At least one Expansion Controller (EC) card is required for the Expansion shelf to function properly. An EC card can be inserted in the leftmost (EC1) or rightmost (EC2) slot on the Expansion shelf (see [Figure 1-4](#)). You can install two EC cards in the shelf for redundancy; if one card should fail, the other maintains proper operation.

The EC card provides the following basic functionality:

- Buffering of timing and framing signals sourced by Clock cards in the master shelf, and delivery of those signals to the Expansion shelf output cards.
- Communication (bi-directional) between Master and Expansion shelves.
- Expansion shelf power monitoring and alarm reporting
- Redundancy management
- Signal integrity monitoring

Rear Panel of the Expansion Shelf

The rear panel of the Expansion shelf contains the following connectors:

Expansion Link – There are four 25-pin connectors along the top of the rear panel: two (in and out) for Link 1 and two (in and out) for Link 2.

Output Connector Modules – These modules define the output signal type (DS1 or CC) for outputs driven by Output Driver cards inserted in the front panel of the shelf. The Expansion shelf can accept up to 16 Output Connector modules (of either type), each providing 20 outputs of the selected type.

Power – There are redundant power connections: A and B.

Expansion Output Connector Modules

Two types of Output Connector modules are available for the Expansion shelf. One type provides 20 DS1 outputs (090-55591-02); the other provides 20 CC outputs (090-55593-02). These modules are similar in design to the Output Connector modules used on the Master shelf, but the form factor of the Output Connector modules is different for Expansion shelves. These cards are described in [Output Connector Modules](#), on page 54.

There are two cables available for connecting Output Connector modules in the Expansion (or Master) shelf to the wire-wrap panels.

1. A flat ribbon cable (060-55591-01) connects a TimeHub 5500 Output Connector module to the 80-output wire-wrap panel (090-41902-01).
2. A round cable (060-55591-02) connects a TimeHub 5500 Output Connector module to the 160-output high-density wire-wrap panel (090-55595-01). This cable reduces cabling congestion that could be associated with wiring for the 320 outputs available on the Expansion shelf. Each output module (990-5559x-02) includes this cable. Note that the round cable/high-density wire-wrap panel combination can be used with either a Master or Expansion shelf. This wire-wrap panel is delivered with the Expansion shelf.

The cable connection from the Output Connector module is the same (form factor and pinout) on the Master and Expansion shelf Output Connector modules, so cabling used to connect Master shelf outputs to a wire-wrap panel will also work on an Expansion shelf.

The Master shelf (990-55505-01) includes one high-density wire-wrap panel (groups A through D) and the Expansion shelf (990-55505-02) includes two high-density wire-wrap panels (groups A through D and groups E through H). Additional wire-wrap panels can be ordered separately; see [Ordering and Parts List](#), on page 59.

Output Driver Cards and Output Connector Modules

Each Output Driver card is associated with its Output Connector card by the letter groups (A through H) on the front and rear panels. Each letter group has two Output Driver card slots and two Output Connector module locations. The two Output Driver card slots are redundant; if two cards are installed and one is disabled, the other card maintains the outputs. The two Output Connector cards are *not* redundant; each card supports 20 output channels.

Two Output Connector cards are required to support the 40 outputs generated by the Output Driver card. The upper (top) module provides outputs 1 through 20 for that particular letter group, and the lower module provides outputs 21 through 40 for that same letter group. If 20 or fewer outputs of the same type are desired, there is no need to load both Output Connector module locations.

The Output Driver cards have LEDs that indicate when an associated Output Connector module is installed on the rear panel of the shelf. Indicators are provided for ports 1 through 20 and ports 21 through 40. If neither the CC nor DS1 LED is lit, then an Output Connector module is not installed.

Redundancy Considerations

The interconnections between the Master and Expansion shelf are designed to support redundancy in several areas. Each area is independent of the others; if one type of redundancy is lost the other areas of redundancy are not compromised.

Clock Redundancy

The two Clock cards in the Master shelf provide the Expansion shelf with clock timing, framing, and communication. If either Clock card is removed, the Expansion shelf continues to receive the necessary signaling from the other Clock card. This is essentially the same way Clock cards provide redundant timing to Output cards on a Master shelf; the redundant clock signaling is conveyed between shelves via the link cables.

Link Cable Redundancy

Each link cable conveys identical information from the master shelf to the Expansion shelf. Master shelf CLK1 and CLK2 signaling is present on both link cables; if one link is broken, the Expansion shelf can still receive timing from the Clock card(s) installed in the Master shelf.

Expansion Controller Card Redundancy

Each EC card receives complete signaling information from both link cables. When both links are present, each EC card is receiving two sets of identical signaling. If either EC card is removed, the remaining EC card provides all of the necessary signaling between the output cards in the Expansion shelf and the clocks in the Master shelf.

Output Driver Card Redundancy

Each Output Driver card in an Expansion shelf slot-pair (“A”, “B”, ..., “H”) receives clocking information from the Clock card(s) installed in the Master shelf. If both Clock cards are installed in the Master shelf, then each Output card receives clocks from each, with preference given to the active Clock (as indicated by the Active LED on the Clock card). Only one Output card per letter group is needed to create output signals. Adding a second Output card to the letter group provides protection if either Output card fails.

Communicating With the Expansion Shelf

The TimeHub 5500 Master shelf automatically attempts to communicate with the EC card(s) in an Expansion shelf. When they respond, the Master shelf sets the TL1 keyword ECLKEXP for the cards to Y. The Master shelf then reports alarms or events related to that Expansion shelf. If no EC cards are present, the ECLKEXP remains at the default value of N. When ECLKEXP is N, the TimeHub 5500 Master shelf does not expect communication from an EC card and no Expansion shelf-related events are reported. This keyword is described in the *TL1 Reference Guide*.

If one of the EC cards is removed, an event (keyword EXCLKGONE) is reported indicating that this card is missing. When the card is reinstalled, the event clears.

If you permanently remove an Expansion shelf from a TimeHub 5500 system, manually set the value of ECLKEXP for the targeted EC card(s) to N. Any events associated with the EC card will be cleared.

TimeScan THC Software

The TimeHub 5500 is delivered with a software application called TimeScan THC. This application is a craft graphical user interface (GUI) that provides a point-and-click interface for configuring and maintaining the TimeHub 5500. [Chapter 4, Testing and Configuring the TimeHub](#) contains procedures that use TimeHub THC. Use the built-in Help system in TimeHub THC to answer questions regarding its use.

Chapter 2 Engineering & Ordering Information

This chapter includes:

- [Overview](#)
- [Wire-wrap Panels](#)
- [Card Overview](#)
- [Ordering and Parts List](#)
- [User-Supplied Tools and Materials](#)

Overview

This chapter describes the cards and accessories available for the TimeHub 5500.

If any difficulties are encountered during the installation process, contact Symmetricom Global Services. Refer to [Contacting Symmetricom Global Services](#), on page 202 for telephone numbers. Global Services includes Product Technical Support for technical information, and Customer Service for information about an order, RMAs, and other information.

Wire-wrap Panels

Symmetricom provides several wire-wrap adapter panels to connect the TimeHub 5500 to office wiring. [Figure 2-1](#) illustrates the High-Density Wire-wrap Adapter Panel that is delivered with the shelf; [Table 2-1](#) lists the available wire-wrap adapter panels and their part number. The cabling to the panel is supplied with the Output Connector module (see [Output Connector Modules](#), on page 54).

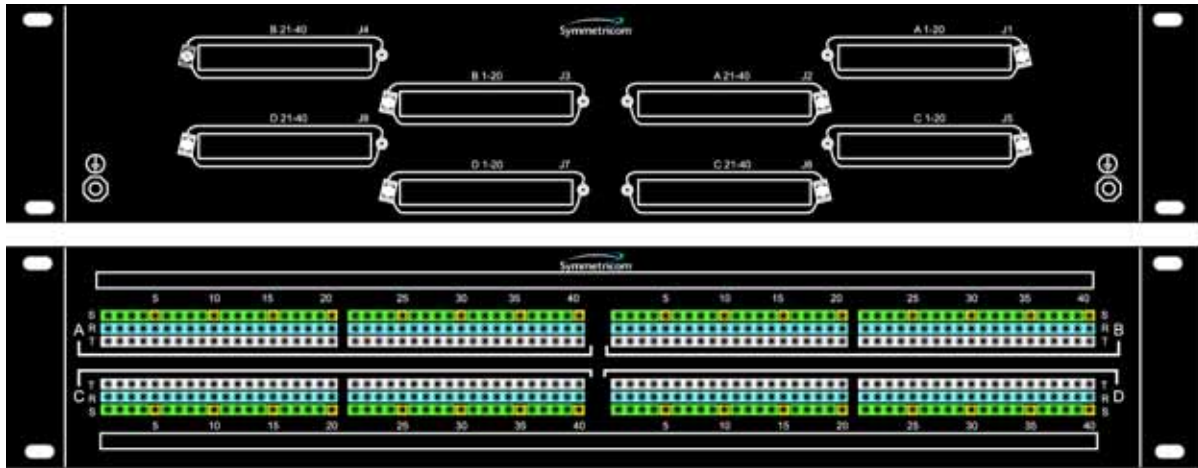

thub0015

Figure 2-1. Front and Rear of the High-Density Wire-wrap Adapter Panel

Other panels may be used with the TimeHub when you use appropriate interconnecting cables (see [Table 2-2](#)). Contact your Symmetricom representative or Symmetricom Global Services to obtain the proper cables.

Table 2-1. Wire-Wrap Panels Available for the TimeHub 5500

Description	Part Number
High capacity wire-wrap panel labeled A-D for Master/Remote shelves	093-55595-01
High capacity wire-wrap panel labeled A-D for Expansion shelves	093-55595-01
High capacity wire-wrap panel labeled E-H for Expansion shelves	093-55595-02

Table 2-2. Wire-Wrap Connection Cables

Description	Part Number
4-foot (122 cm) interconnect cable	060-55591-02
10-foot (305 cm) interconnect cable	060-55591-10
20-foot (710 cm) interconnect cable	060-55591-20

Symmetricom also offers cable management kits made of ABS plastic to ensure a neat installation. These kits are available in 1 RU and 2 RU heights to meet a variety of installation needs. [Table 2-3](#) lists the cable management kits available. Each of these kits includes two cable trays used for a single wire-wrap adapter panel.

Table 2-3. Cable Management Panels Available for the TimeHub 5500

Description	Part Number
Cable management kit, 1 RU	093-55595-11
Cable management kit, 2 RU	093-55595-12

Accessories

Symmetricom provides a range of accessories to ensure a complete and professional installation. [Table 2-4](#) lists the available accessories.

Table 2-4. Accessories for Adapter Panels

Description	Part Number
Blank panel for Clock card	093-55598-01
Blank panel for Output Driver card	093-55598-02
Blank panel for Expansion Controller card	093-55598-03
Blank panel for Output module – Master chassis	093-55599-01
Blank panel for single Output module – Expansion chassis	093-55599-02
Blank panel for two Output modules – Expansion chassis	093-55599-03

Card Overview

This section describes the cards available for the TimeHub 5500.

Clock Cards

The function of the Clock cards in the TimeHub 5500 is described in [Clock Cards](#), on page 24.

- Standard Clock cards: These cards are equipped with five inputs (four DS1 and one 5/10 MHz) and do not support Expansion shelves.
 - Five-input with an ST2E rubidium oscillator (090-55513-01)
 - Five-input with an ST3E quartz oscillator (090-55511-01)
- Extended-capacity Clock cards: These cards are equipped with nine inputs (four DS1, four monitoring inputs, and one 5/10 MHz) and support Expansion shelves. If you plan to use an Expansion shelf (or shelves) attached to a Master shelf, you must use extended-capacity Clock cards.
 - Nine-input with an ST2E rubidium oscillator (090-55514-02)
 - Nine-input with an ST3E quartz oscillator (090-55512-02)

Figure 2-2 illustrates the front panel of the Clock card.

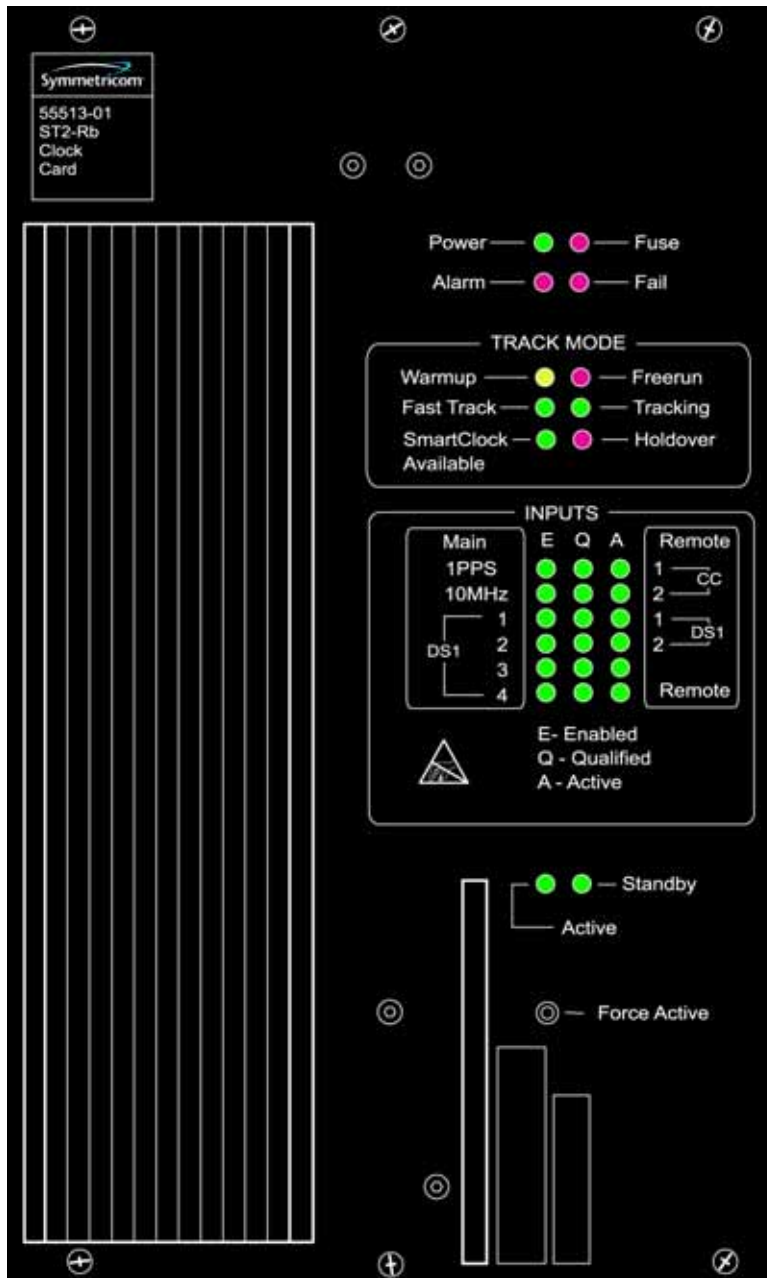

thub0010

Figure 2-2. Front Panel of the ST2-Rb Clock Card

The LED status indicators on the Clock card are described in [Figure 2-5](#).

Table 2-5. Clock Card Front Panel Indicators

Indicator	Color	Description
Power	Green	<ul style="list-style-type: none"> ■ On = The Clock card is receiving power ■ Off = No power present
Fuse	Red	<ul style="list-style-type: none"> ■ On = The Clock card fuse is open ■ Off = The Clock card fuse is not open
Alarm	Red	<ul style="list-style-type: none"> ■ On = An alarm condition is present ■ Off = No alarm condition is present
Fail	Red	<ul style="list-style-type: none"> ■ On = A hardware or firmware fault has occurred ■ Off = No hardware or firmware faults have occurred
Warmup	Amber	<ul style="list-style-type: none"> ■ On = Clock card is in Warmup state ■ Off = Clock card is not in Warmup state
Freerun	Red	<ul style="list-style-type: none"> ■ On = The Clock card is generating an output without using tracking information from a reference source ■ Off = The Clock card is not in Freerun state
Tracking	Green	<ul style="list-style-type: none"> ■ On = The Clock card is tracking a qualified input ■ Off = The Clock card is not tracking a qualified input
Fast Track	Green	<ul style="list-style-type: none"> ■ On = The Clock card has warmed up, is tracking, and is providing a usable output, but has not yet achieved Smart Clock (optimal quality) output ■ Off = The Clock card is not in Fast Track state
SmartClock Available	Green	<ul style="list-style-type: none"> ■ On = The system has gathered sufficient information during tracking to provide Smart Clock (optimal quality) holdover output if necessary ■ Off = The system has not gathered sufficient information during tracking to provide Smart Clock (optimal quality) holdover output if necessary
Holdover	Green	<ul style="list-style-type: none"> ■ On = All inputs are lost or unacceptable, and the system is now using the internal oscillator which is using recent tracking data from a qualified reference to provide the output ■ Off = The system is not in Holdover state
Inputs E	Green	<ul style="list-style-type: none"> ■ On = The associated reference input is enabled (E) for tracking ■ Off = The associated reference input is not enabled (E) for tracking

Table 2-5. Clock Card Front Panel Indicators (Continued)

Indicator	Color	Description
Inputs Q	Green	<ul style="list-style-type: none"> ■ On = The associated reference input is qualified (Q) for tracking ■ Off = The associated reference input is not qualified (Q) for tracking
Inputs A	Green	<ul style="list-style-type: none"> ■ On = The associated reference input is being actively (A) used for tracking. In a remote system, this light indicates the shelf being configured as a remote shelf. In this case, the corresponding 'Q' and 'E' lights are off ■ Off = The associated reference input is not being actively (A) used for tracking
Active	Green	<ul style="list-style-type: none"> ■ On = This card is the synchronization signal source for all output cards ■ Off = This card is not the synchronization signal source for all output cards
Standby	Green	<ul style="list-style-type: none"> ■ On = This card is generating an output that is phase-locked to the output of the other (active) Clock card ■ Off = This card is not generating an output that is phase-locked to the output of the other (active) Clock card
Force Active (pushbutton)	–	Pressing this button forces the Clock card to be the active card

Management Card

The function of the Management card is described in [Management Card](#), on page 24. The Management card kit (990-55542-01) includes the Management card, a DB9 cable, and a CD that contains the TimeScan THC software. [Figure 2-3](#) illustrates the front panel of the Management card.

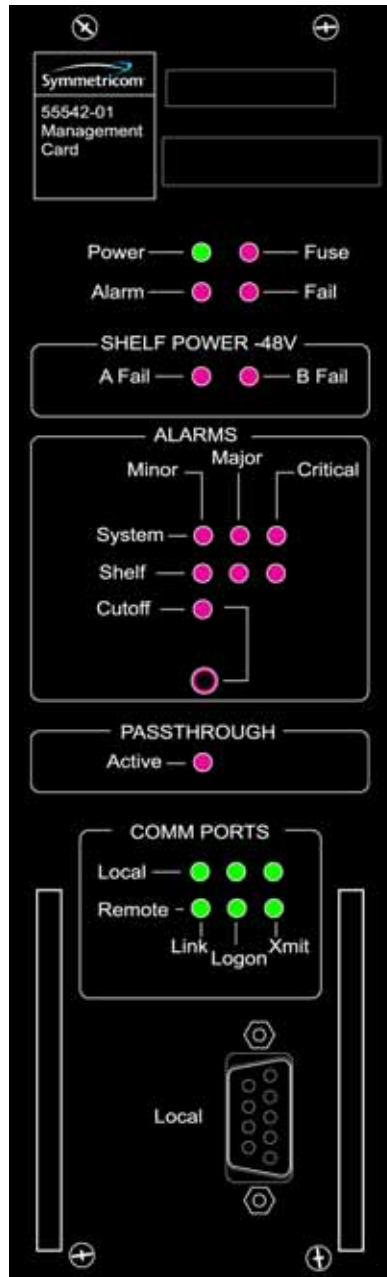

thub0008

Figure 2-3. Front Panel of the Management Card

The LED status indicators on the Management card are described in [Table 2-6](#).

Table 2-6. Management Card Front Panel Indicators

Indicator	Color	Description
Power	Green	<ul style="list-style-type: none"> ■ On = The card is receiving power ■ Off = No power present
Fuse	Red	<ul style="list-style-type: none"> ■ On = The Management card fuse is open ■ Off = The Management card fuse is not open
Alarm	Red	<ul style="list-style-type: none"> ■ On = An alarm condition is present ■ Off = No alarm condition is present
Fail	Red	<ul style="list-style-type: none"> ■ On = A hardware or firmware fault has occurred ■ Off = No hardware or firmware faults have occurred
Shelf Power –48V A Fail	Red	<ul style="list-style-type: none"> ■ On = Input voltage is below the normal level ■ Off = Input voltage is at the normal level
Shelf Power –48V B Fail	Red	<ul style="list-style-type: none"> ■ On = Input voltage is below the normal level ■ Off = Input voltage is at the normal level
Alarms System Minor	Red	<ul style="list-style-type: none"> ■ On = A minor alarm condition exists outside the shelf ■ Off = There is no minor alarm outside the shelf
Alarms System Major	Red	<ul style="list-style-type: none"> ■ On = A major alarm condition exists outside the shelf ■ Off = There is no major alarm outside the shelf
Alarms System Critical	Red	<ul style="list-style-type: none"> ■ On = A critical alarm condition exists outside the shelf ■ Off = There is no critical alarm outside the shelf
Alarms Shelf Minor	Red	<ul style="list-style-type: none"> ■ On = A minor alarm condition exists in the shelf ■ Off = There is no minor alarm within the shelf
Alarms Shelf Major	Red	<ul style="list-style-type: none"> ■ On = A major alarm condition exists in the shelf ■ Off = There is no major alarm within the shelf
Alarms Shelf Critical	Red	<ul style="list-style-type: none"> ■ On = A critical alarm condition exists in the shelf ■ Off = There is no critical alarm within the shelf
Audible Alarms Cutoff LED	Red	<ul style="list-style-type: none"> ■ On = An audible or visible alarm was present. The audible alarm has been silenced, but the alarm condition still exists ■ Off = The alarm cutoff function has not been activated
Audible Alarms Cutoff Pushbutton	–	Silences all audible alarms when pressed
Comm Ports Local Link	Green	<ul style="list-style-type: none"> ■ On = The local communication port is enabled ■ Off = The local communication port is disabled
Comm Ports Local Logon	Green	<ul style="list-style-type: none"> ■ On = A user is logged on the local port ■ Off = A user is not logged on the local port

Table 2-6. Management Card Front Panel Indicators (Continued)

Indicator	Color	Description
Comm Ports Local Xmit	Green	<ul style="list-style-type: none">■ On = Data is being transferred on the local port■ Off = Data is not being transferred on the local port
Comm Ports Remote Link	Green	<ul style="list-style-type: none">■ On = The network connection is enabled■ Off = The network connection is disabled
Comm Ports Remote Logon	Green	<ul style="list-style-type: none">■ On = A user is logged on the network■ Off = A user is not logged on the network
Comm Ports Remote Xmit	Green	<ul style="list-style-type: none">■ On = Data is being transferred on the network■ Off = Data is not being transferred on the network

Output Driver Cards

Each Output Driver card (090-55581-01) supports 40 DS1 or Composite Clock outputs, and can be installed in either a Master/Remote shelf or in an Expansion shelf. The Master/Remote shelf contains eight slots for Output Driver cards, arranged in four groups labeled A through D. The Expansion shelf contains 16 slots for Output Driver cards, arranged in eight groups labeled A through H.



Note: The “D” group on a Master/Remote shelf supports 20 protected or non-protected outputs. Groups A, B, and C support 40 protected or non-protected outputs.

To maintain outputs should an Output Driver card fail, you can install them in pairs within a group. If one Output Driver card in a group fails, then the other card maintains the outputs with minimal disruption. If you do not need protected outputs, you can install one Output Driver card in either slot of a group.

Figure 2-4 shows the front panel of the Output Driver card.



Figure 2-4. Front Panel of the Output Driver Card

The LED status indicators on the Output Driver card are described in [Table 2-7](#).

Table 2-7. Output Driver Card Front Panel Indicators

Indicator	Color	Description
Power	Green	<ul style="list-style-type: none"> ■ On = The card is receiving power ■ Off = No power present
Fuse	Red	<ul style="list-style-type: none"> ■ On = The Output Driver card fuse is open ■ Off = The Output Driver card fuse is not open
Alarm	Red	<ul style="list-style-type: none"> ■ On = An alarm condition is present ■ Off = No alarm condition is present
Fail	Red	<ul style="list-style-type: none"> ■ On = A hardware or firmware fault has occurred ■ Off = No hardware or firmware faults have occurred
Ports 1–20 DS1	Green	<ul style="list-style-type: none"> ■ On = A DS1 Output Connector module is connected to ports 1 through 20 ■ Off = There is no Output Connector module connected to ports 1 through 20; no outputs can be generated
Ports 1–20 CC	Green	<ul style="list-style-type: none"> ■ On = A CC Output Connector module is connected to ports 1 through 20 ■ Off = There is no Output Connector module connected to ports 1 through 20; no outputs can be generated
Ports 21–40 DS1	Green	<ul style="list-style-type: none"> ■ On = A DS1 Output Connector module is connected to ports 21 through 40 ■ Off = There is no Output Connector module connected to ports 21 through 40; no outputs can be generated
Ports 21–40 CC	Green	<ul style="list-style-type: none"> ■ On = A CC Output Connector module is connected to ports 21 through 40 ■ Off = There is no Output Connector module connected to ports 21 through 40; no outputs can be generated

Input/Alarm Connector Module

The Input/Alarm Connector module (090-55561-01) mounts on the rightmost position on the rear panel of a Master/Remote shelf. The module is shown in [Figure 2-5](#). Expansion shelves do not use an Input/Alarm Connector module.

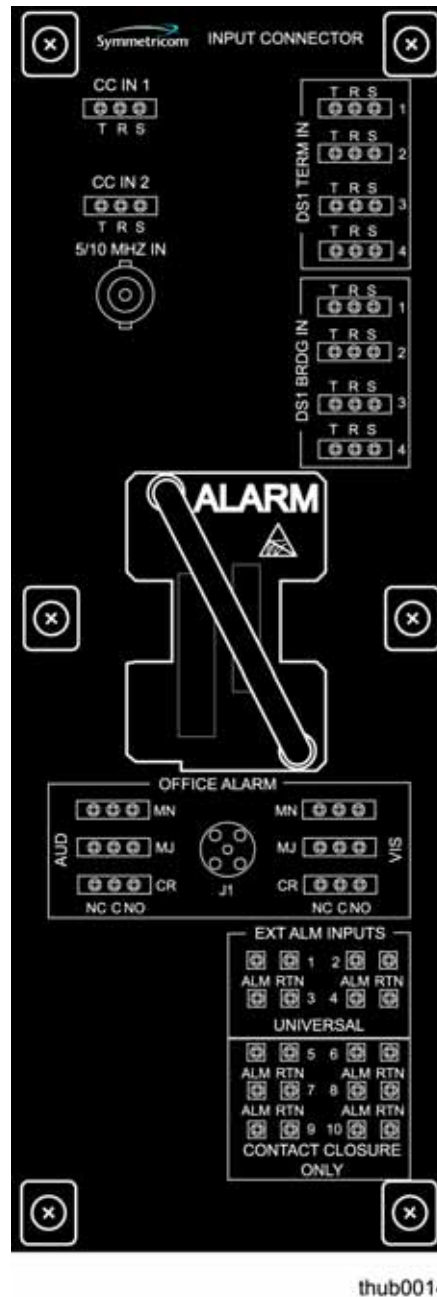

Figure 2-5. Front Panel of the Input/Alarm Connector Module

Output Connector Modules

The TimeHub 5500 can provide either Composite Clock (CC) or DS1 output signals. The Output Connector module determines the type of signal. You can install a combination of Output Connector module types to meet the needs at the site. Output Connector modules are *not* interchangeable between the Master/Remote shelf and the Expansion shelf.

Master/Remote shelf Output Connector modules:

- DS1: 990-55591-01
- CC: 990-55593-01

Expansion Shelf Output Connector modules:

- DS1: 990-55591-02
- CC: 990-55593-02

Output Connector modules on the Master shelf are distinguished by the handle on the card. Each DS1 Output Connector module is labeled “DS1” and has a black handle; each CC Output Connector module is labeled “CC” and has a blue handle. [Figure 2-6](#) illustrates the two types of Output Connector modules for the Master/Remote shelf, and [Figure 2-7](#) illustrates the Output Connector modules for the Expansion shelf. Output Connector modules for the Expansion shelf are distinguished only by part number; be sure that you install the appropriate module for your installation.

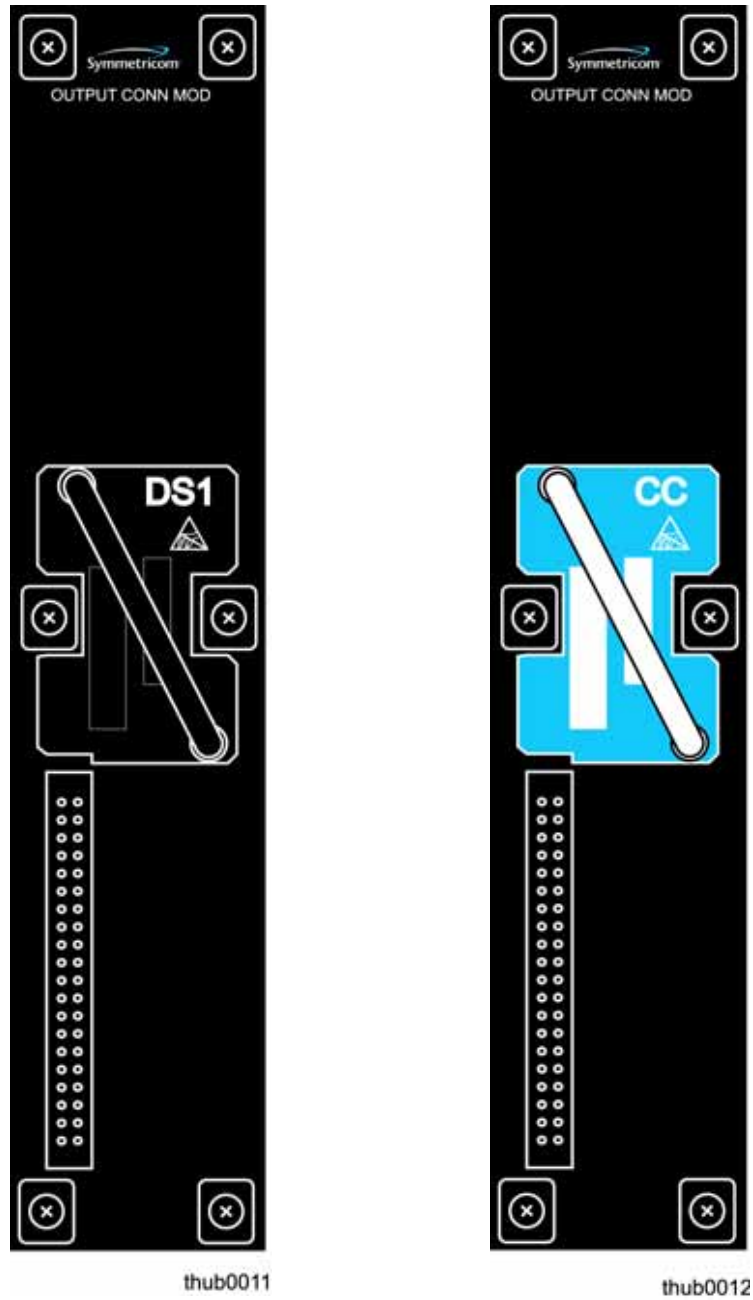

Figure 2-6. Output Connector Modules for the Master/Remote Shelf:
DS1 (left) and CC (right)

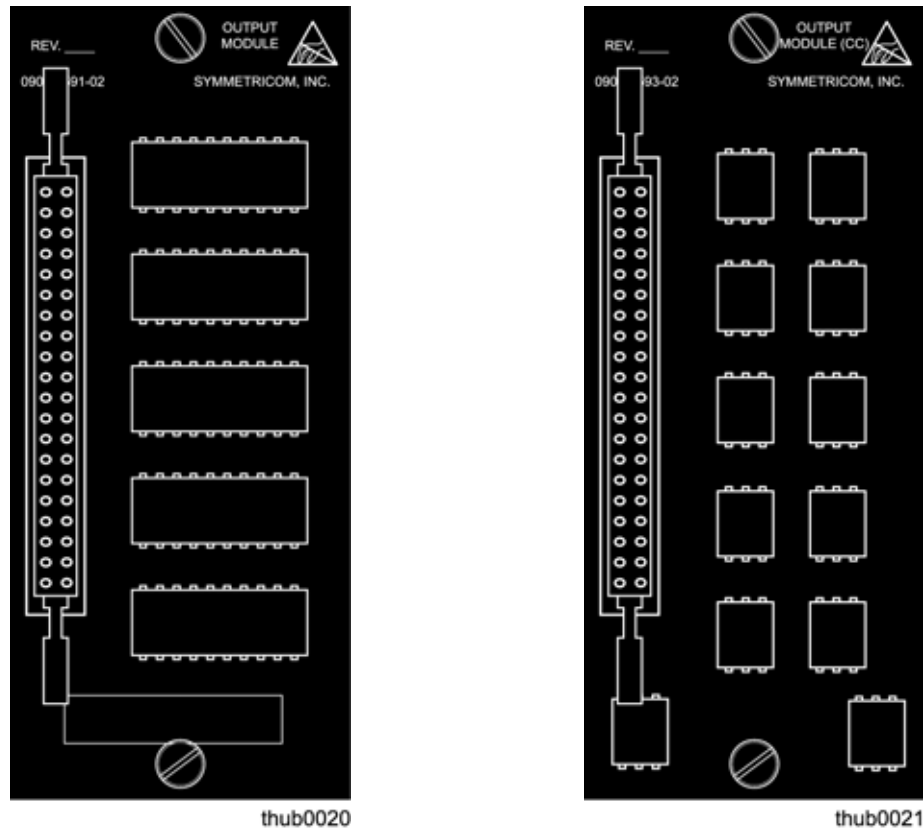

Figure 2-7. Output Connector Modules for the Expansion Shelf:
DS1 (left) and CC (right)

You can install up to seven Output Connector modules on a Master/Remote shelf, and up to 16 Output Connector modules on an Expansion shelf. See [Installing Rear Panel Modules](#), on page 77, for instructions on installing Output Connector modules; [Making Signal Connections](#), on page 81, provides instructions on connecting the Output Connector modules to the Output panels.

Expansion Controller Card

The Expansion Controller card (090-55545-01) is only used in the Expansion shelf. At least one Expansion Controller (EC) card is required for the Expansion shelf to function properly. An EC card can be inserted in the leftmost (EC1) or rightmost (EC2) slot on the Expansion shelf (see [Figure 2-8](#)). The overall function of the EC card is the same regardless of which of these locations are used. The reason to use two EC cards in the shelf is entirely to support redundancy. If one card should fail, the other will maintain proper operation.

The EC card provides the following functions:

- Buffering of timing and framing signals sourced by Clock cards in the Master shelf, and delivery of those signals to the Expansion shelf output cards.

- Communication (bi-directional) between Master and Expansion shelves.
- Expansion shelf power monitoring and alarm reporting
- Redundancy management
- Signal integrity monitoring

Front Panel Indicators

Figure 2-8 illustrates the front panel of the Expansion Controller card.



Figure 2-8. Front Panel of the Expansion Controller Card

The LED status indicators on the Expansion Controller card are described in [Table 2-8](#).

Table 2-8. Expansion Controller Card Front Panel Indicators

Indicator	Color	Description
Power	Green	<ul style="list-style-type: none"> ■ On = The card is receiving power ■ Off = No power present
Fuse	Red	<ul style="list-style-type: none"> ■ On = The Expansion Controller card fuse is open ■ Off = The Expansion Controller card fuse is not open
Shelf Alarm	Red	<ul style="list-style-type: none"> ■ On = An alarm condition is present ■ Off = No alarm condition is present
Fail	Red	<ul style="list-style-type: none"> ■ On = A hardware or firmware fault has occurred ■ Off = No hardware or firmware faults have occurred
Shelf Power	Green/Red	<ul style="list-style-type: none"> ■ Green = Power is being successfully supplied to the associated shelf power terminal (A or B) ■ Red = Power is not being successfully supplied to the associated power terminal
Expansion Links	Green/Red	<ul style="list-style-type: none"> ■ Green = Proper timing, framing, and communication is coming from the Master shelf ■ Red = The link cable is attached but there is a problem receiving either clock timing, clock framing, or communication from the Master shelf ■ Off = The link cable is not connected, or the Clock card(s) are in warmup mode

When the Shelf Alarm LED is red, an alarm condition is detected by the Expansion Controller card. The alarm is reported back through the Management card in the master shelf. Specific alarms detected are:

- Shelf Power A or B not detected. This illuminates the Alarm LED as well as appropriate Shelf Power LED (red). Associated TL1 events are EXPWRA and EXPWRB (Expansion Power Fail on terminal A or B).
- The Expansion Controller card is receiving a good link but it is not associated with its “preferred” master shelf clock.

The concept of a “preferred” Clock is used to better support redundancy. During normal operation, each Expansion Controller card takes its clock from a different Clock card. However, an Expansion Controller card can take its clock from either Clock card so it is not critical that an EC card get its clock from its preferred source. This alarm is reported simply to indicate the situation when this card is currently not getting its clock from the preferred source. Specifically:

- An EC card inserted into the EC1 (leftmost) slot “prefers” to take its clock from CLK1 (leftmost Clock card on the Master shelf). If it can obtain a valid link only by using CLK2, the alarm LED lights.
- An EC card inserted into the EC2 (rightmost) slot “prefers” to take its clock from CLK2 (rightmost Clock card on the Master shelf). If it can obtain a valid link only by using CLK1, the alarm LED lights.

The leftmost Clock card and leftmost EC card are a preferred pair while the rightmost Clock card and rightmost EC card are a preferred pair.

Ordering and Parts List

Table 2-9 lists the basic components that comprise a Master or Remote shelf.

Table 2-9. Master and Remote Shelf Basic Components

Item	Part Number	Quantity	Included Items
Master shelf kit	990-55500-01	1	<ul style="list-style-type: none"> ■ Master shelf (090-55501-03) ■ One Wire-wrap Input module (090-55561-01) ■ One Wire-wrap panel (190-55595-01) ■ 19 in. and 23 in. mounting hardware ■ System manuals
Management card kit	990-55542-01	1	<ul style="list-style-type: none"> ■ Management card (090-55542-01) ■ DB9 connection cable ■ CD with TimeScan THC and complete TimeHub documentation
Clock cards	090-5551x-0x	1 (minimum) 2 (recommended)	<p>Quartz clock cards:</p> <ul style="list-style-type: none"> ■ Quartz 5 input (090-55511-01) Note: This clock does not support Expansion shelves. ■ Quartz 9 input (090-55512-02) Note: This clock supports Expansion shelves. <p>Rubidium clock cards:</p> <ul style="list-style-type: none"> ■ Rubidium 5 input (090-55513-01) Note: This clock does not support Expansion shelves. ■ Rubidium 9 input (090-55514-02) Note: This clock supports Expansion shelves.

Table 2-9. Master and Remote Shelf Basic Components (Continued)

Item	Part Number	Quantity	Included Items
Output Driver cards	090-55581-01	1 (minimum) 2 (recommended) up to 8 per Master/ Remote	<ul style="list-style-type: none"> ■ Output card (090-55581-01)
DS1 Output module kit	990-55591-01	1 (minimum) 2 (recommended) up to 7 DS1 and CC total per Master/Remote	<ul style="list-style-type: none"> ■ DS1 Output module (090-55591-01) ■ Round RJ-21 cable (060-55591-02)
CC Output module kit	990-55593-01	1 (minimum) 2 (recommended) up to 7 DS1 and CC total per Master/Remote	<ul style="list-style-type: none"> ■ CC Output module (090-55593-01) ■ Round RJ-21 cable (060-55591-02)
Blank panels for Output card spaces	093-55598-02	8 minus number of installed Output cards	<ul style="list-style-type: none"> ■ Optional to fill out output card space

Table 2-10 lists the components of an Expansion shelf.

Table 2-10. Expansion Shelf Basic Components

Item	Part Number	Quantity	Included Items
Expansion shelf kit	090-55505-02	1	<ul style="list-style-type: none"> ■ Expansion shelf (090-55505-03) ■ Wire-wrap panel (190-55595-01) ■ Wire-wrap panel (190-55595-02) ■ Line terminator (190-55505-01) x 2 ■ Gender changer (128-55505-01) ■ Connection cable (060-55505-01) x 2 ■ 19 in. and 23 in. mounting hardware ■ System manuals ■ CD with TimeScan THC and complete TimeHub documentation
Expansion Controller card	090-55545-01	1 (minimum) 2 (recommended)	<ul style="list-style-type: none"> ■ Expansion Controller card (090-55545-01)
Output Driver cards	090-55581-01	1 (minimum) 2 (recommended) up to 16 per Expansion shelf	<ul style="list-style-type: none"> ■ Output card (090-55581-01)

Table 2-10. Expansion Shelf Basic Components (Continued)

Item	Part Number	Quantity	Included Items
DS1 Output module kit for Expansion shelf	990-55591-02	1 (minimum) 2 (recommended) up to 16 DS1 and CC total per Expansion shelf	<ul style="list-style-type: none"> ■ DS1 Output module (090-55591-02) ■ Round RJ-21 cable (060-55591-02)
CC Output module kit for Expansion shelf	990-55593-02	1 (minimum) 2 (recommended) up to 16 DS1 and CC total per Expansion shelf	<ul style="list-style-type: none"> ■ CC Output module (090-55593-02) ■ Round RJ-21 cable (060-55591-02)
Blank panels for Output card spaces	093-55598-02	16 minus number of installed Output cards	<ul style="list-style-type: none"> ■ Optional to fill out output card space

Table 2-11 lists the accessories and spare parts that can be ordered separately.

Table 2-11. Accessories and Spare Parts

Item	Part Number	Description
Accessories		
Blank panel for Clock card	093-55598-01	Blank panel to cover slot of uninstalled input/clock card. Master/Remote shelf only.
Blank panel for Output card	093-55598-02	Blank panel to cover slot of uninstalled output card. Master/Remote or Expansion shelf.
Blank panel for Expansion Controller card	093-55598-03	Blank panel to cover slot of uninstalled Expansion Controller card. Expansion shelf only.
Blank panel for Output module	093-55599-01	Blank panel to cover space of unused output module. Master/Remote shelf only.
Short blank panel for Output module	093-55599-02	Blank panel to cover space of unused output module slot. Covers one module space. Expansion shelf only.
Long blank panel for Output module	093-55599-03	Blank panel to cover space of unused Output module slot. Covers two module spaces (one group). Expansion shelf only.
Spare Parts		
Wire-wrap input module	090-55561-01	Wire-wrap input board. Master/Remote shelf only.

Table 2-11. Accessories and Spare Parts (Continued)

Item	Part Number	Description
High capacity wire-wrap panel kit	093-55595-01	Wire-wrap panel with 160 outputs labeled A through D. Includes kit to mount on 23 in. rack.
High capacity wire-wrap panel kit	093-55595-02	Wire-wrap panel with 160 outputs labeled E through H. Includes kit to mount on 23 in. rack.

User-Supplied Tools and Materials

User-supplied tools and materials are listed below.

- Phillips-head screwdriver for installing the TimeHub 5500 shelf in a rack
- Phillips-head or Pozidrive screwdriver for tightening or loosening captive screws
- ESD wrist strap for installing cards
- GMT fuse puller
- Digital multimeter (Fluke 77 or equivalent) for verifying power connections to the shelf
- Dual-channel oscilloscope with 100 MHz minimum bandwidth for verifying clock input signal(s) are within the specified input voltage range and checking output waveforms
- Laptop computer with communications software (e.g., Windows Hyperterminal, ProComm Plus, CrossTalk) or TimeScan THC software for setting system parameters

Chapter 3 Installing the TimeHub

This chapter includes:

- [Overview](#)
- [Installation Checklist](#)
- [Unpacking the TimeHub 5500](#)
- [Rack Mounting the TimeHub 5500](#)
- [Configuring the Shelf as a Master or Remote](#)
- [Making Ground and Power Connections](#)
- [Installing Modules into the Rear Panel](#)
- [Making Signal Connections](#)
- [Installing the Cover](#)
- [Installing Expansion Shelves](#)
- [Removing Expansion Shelves](#)

Overview

Install the TimeHub 5500 using the sequence given in this chapter. This chapter covers steps to install the TimeHub 5500 system in preparation for power-up.

If you encounter any difficulties during the installation process, contact Symmetricom Global Services (SGS). See [Contacting Symmetricom Global Services](#), on page 202 for telephone numbers. SGS includes Product Technical Support for technical information, and Customer Service for information about your order, RMAs, and other information.

Site Survey

Before ordering the system, determine the shelf location, the –48 volt power source(s), and the grounding for the shelf. Remember to locate the shelf close to the equipment to be synchronized and as far away as possible from electrical noise sources such as air conditioners, elevator motors, power systems, etc. To avoid the effects of rapid temperature fluctuations, place the shelf so that heating or air conditioning vents do not blow directly on the shelf.

Access to the installation location can only be gained by service personnel or users who have been instructed in the reasons for the restrictions applied to the location and about any precautions that they should take. Access is by lock and key, or other means of security, and is controlled by the authority responsible for the location.

The TimeHub 5500 shelf, when installed, occupies 10.5 in (26.7 cm, 6 RU) of vertical rack space and has a depth of 11.5 in (29.2 cm). The Wirewrap High-Density Adapter Panel delivered with the TimeHub 5500 occupies 3.5 in (8.9 cm, 2 RU) of vertical rack space and has a depth of approximately 4 in (10.1 cm). The optional 1 RU and 2 RU Cable Management kits add 2 RU and 4 RU respectively to each adapter panel on which you install the kit.

Preliminary Procedures

Make sure that the following preparations are in place before installation.

- Ensure that standard installation tools and materials are available, see [Installation Tools and Equipment](#), on page 65.
- Ensure that the system location does not cause electromagnetic interference with other equipment in the area, see [Electromagnetic Interference \(EMI\) Considerations](#), on page 65.
- Ensure that adequate ventilation space is available in the rack or equipment cabinet to safely operate the shelf, see [Ventilation Considerations](#), on page 66.
- Ensure that the mounting rack or equipment cabinet is properly grounded and has power available, see [Making Ground and Power Connections](#), on page 73.



Warning: To avoid accidental power-up of the shelf, remove the A and B fuses on the front panel of the shelf before beginning the TimeHub 5500 installation. The unit is not equipped with a power on/off switch.

Installation Tools and Equipment

You will need the following tools and equipment to install the TimeHub 5500:

- Standard tool kit
- Cable sewing cord or acceptable ties or clamps
- 16 AWG (minimum) wire for –48V, RTN, and frame ground
- 18 AWG wire for connecting office alarms
- 22 AWG shielded twisted pair wire-wrap cable (Amp #640433-7 or equivalent)
- Wire-wrap tool
- No. 10 screws, flat washers, and locking washers for mounting the equipment rack
- Digital Voltmeter
- Straight-through RS-232 cable
- Laptop or PC
- TimeHub THC application (delivered with the TimeHub 5500)

Electromagnetic Interference (EMI) Considerations

Electromagnetic interference (EMI) from one instrument can adversely affect the operation of nearby equipment. To prevent the TimeHub 5500 from interfering with other equipment, it must be installed and operated as described in the following paragraphs.

All cables connected to the TimeHub 5500 should be shielded with “drain” wires connected to the rack ground. Follow local procedures for shield grounding. The screws on all cable shells must be securely fastened to their corresponding connectors on the rear of the unit. While the unit is in operation, there must be a module or blank panel installed in every slot. Also, the captive screws, located at the top and bottom of the module panel, must be properly secured.



Caution: To maintain EMC compliance, use only properly shielded cabling on all telecom signal wiring, including I/O, clocks, and Ethernet connections. Ensure that connections are appropriately grounded.

Ventilation Considerations

For proper ventilation, there should be at least 1 RU (1.75 inches, 4.4 cm) of free space above and below the shelf.



Caution: To avoid excessive heat build-up resulting in equipment damage, provide proper ventilation and cooling of the equipment.

Installation Checklist

To verify that each step in the installation procedure is complete, fill in the checklist in [Table 3-1](#) as you complete the steps. You can complete the procedures in any order your site requires; the procedures in this Guide are in Symmetricom's suggested sequence.

Table 3-1. Installation Checklist

Step	Procedure	Initials
1	Unpacking the TimeHub 5500 , on page 67	
2	Rack Mounting the TimeHub 5500 , on page 67	
3	Configuring the Shelf as a Master or Remote , on page 72	
4	Making Ground and Power Connections , on page 73	
5	Testing Power Connections , on page 76	
6	Installing Modules into the Rear Panel , on page 77	
7	Making Signal Connections , on page 81	
8	Installing the Cover , on page 91	
9	Installing the Management Card , on page 105, including setting the internal switch	
10	Installing the Clock Cards , on page 108, including setting the internal switch	
11	Installing Output Driver Cards , on page 111	
12	Installing Expansion Shelves , on page 92	
13	Installing Expansion Controller Cards , on page 112	
14	Installing Output Connector Modules , on page 94	
15	Installing Output Driver Cards , on page 113	

Unpacking the TimeHub 5500

The TimeHub 5500 is packaged to protect it from normal shock, vibration and handling damage. Care should be taken during unpacking and installation to avoid damaging the unprotected unit.



Caution: To avoid damage, use proper static control precautions when handling equipment! Protect the equipment against ESD (Electrostatic Discharge) by using a grounded protective wrist strap and normal equipment grounding.

1. Unpack all equipment carefully and check it against the purchase order.
2. Inspect the equipment for shipping damage, including bent or loose hardware, broken connectors, or other visible defects. Notify Symmetricom and the carrier who delivered the equipment if you suspect that it was damaged in transit.

If any items are missing, contact Symmetricom Global Services.



Recommendation: Keep all packaging materials in the event the shelf or components must be returned or shipped to another location.

Rack Mounting the TimeHub 5500

The procedure for rack mounting a Master, Remote, or an Expansion shelf is identical.



Note: If you are using an existing connection panel, follow the procedures in an approved Method of Procedure (MOP) for cutting over an existing shelf.

Mounting the Shelf

The shelf mounts flush to the rack or at distances of 2 inches (5.1 cm), or 5 inches (12.7 cm) from the front of the rack, as shown in [Figure 3-1](#).

1. Attach a mounting bracket to each side of the shelf by aligning two columns (two holes per column) of the bracket with the holes on the side of the shelf. Use suitable screws for attaching the mounting bracket. Ensure that both brackets are attached at equal distances from the front of the shelf.
2. Mount the instrument to the rack rails with the appropriate number of screws and washers for the rack.

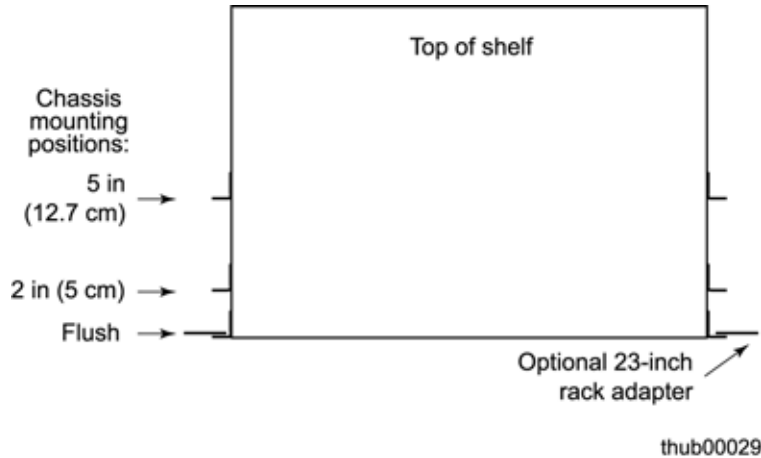

Figure 3-1. Mounting Options for the Shelf

Installing the Wire-wrap Panel

If you are using an existing wire-wrap panel (for example, part number 090-41902-01), leave the panel in the rack. Replace the cables using an approved Method of Procedure (MOP) for cutting over from an existing shelf.

If you are installing the wire-wrap panel delivered with the Master shelf (shown in [Figure 3-2](#)), mount the panel in the rack *after* you install the shelf. Mount the panel above or below the shelf, leaving enough space (at least 1 RU) for cable management above and below the wire-wrap panel. A Cable Management kit is available in 1U or 2U heights (093-55595-11 and 093-55595-12, respectively) to complete the installation. A rack extender bracket is included for 23-inch racks. [Figure 3-3](#) illustrates one way to assemble the wire-wrap panel with the Cable Management kit and the rack extender bracket.



Recommendation: For most applications, Symmetricom recommends that you install the Wire-wrap panel and Cable Management kits on the *rear* of the rack rails. This improves the cable routing from the rear of the shelf to the wire-wrap panel.

You can mount the wire-wrap panel with either the connectors or the wire-wrap pins facing the front of the rack; follow your company procedures.

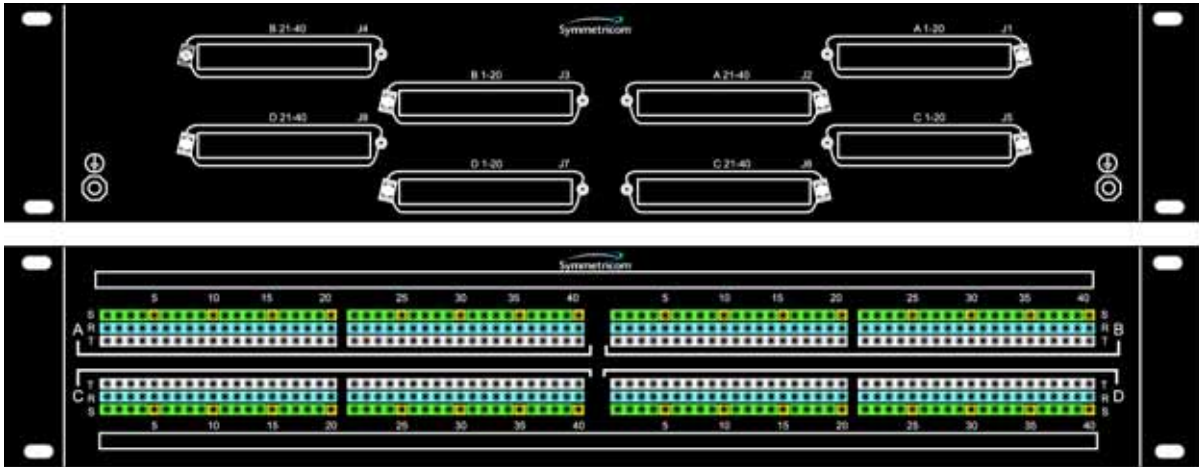

thub0015

Figure 3-2. High-Density Wire-wrap Panel (Front and Rear)

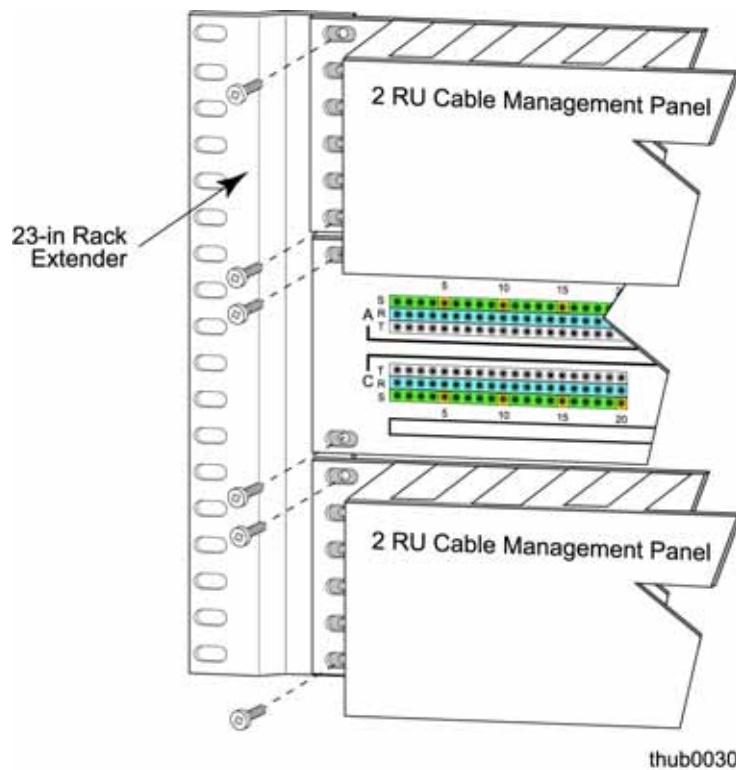

Figure 3-3. Assembling the Rack Extenders for a 23-inch Shelf

If you are installing an Expansion shelf, mount one wire-wrap panel above the Expansion shelf and the other below the Expansion shelf, leaving 1 RU above and below each wire-wrap panel for ventilation. A [Figure 3-4](#) illustrates an example of a Master shelf and wire-wrap panel, and [Figure 3-5](#) shows an example of a Master and Expansion shelf with three wire-wrap panels.

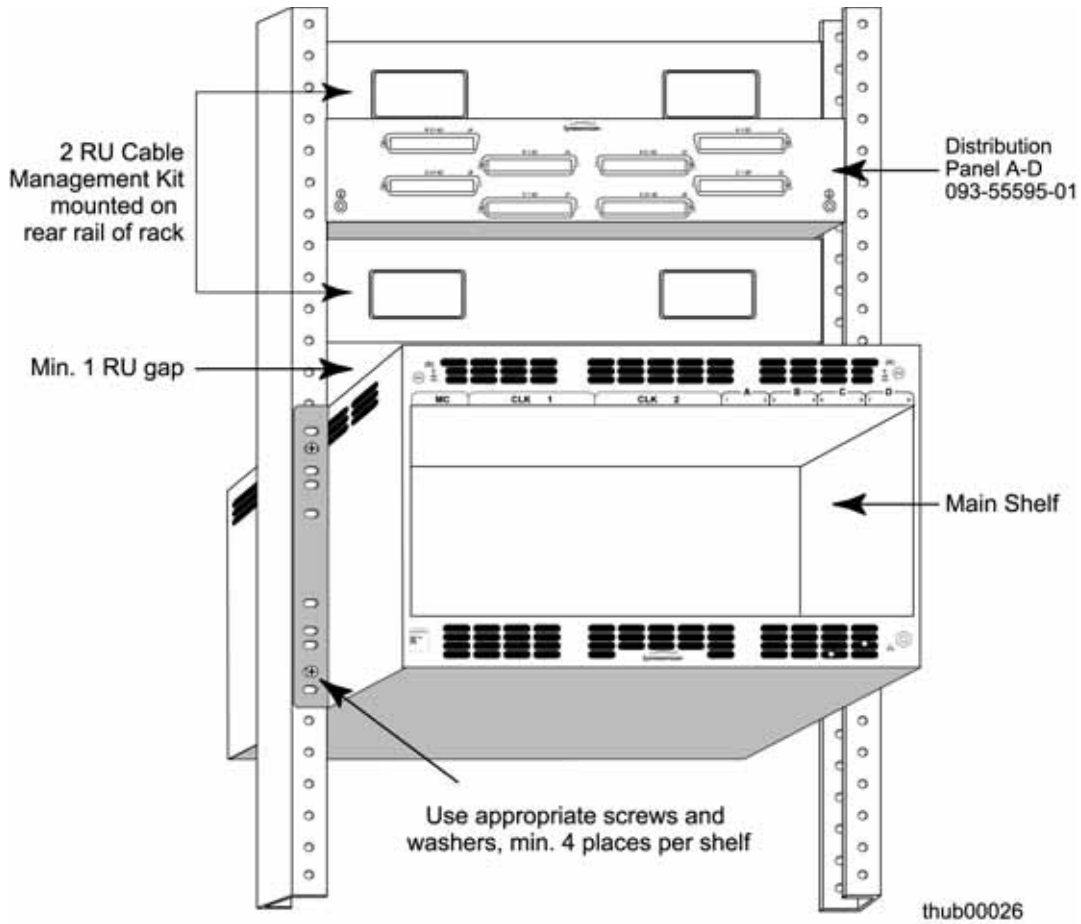

Figure 3-4. Sample Rack Installation of a Master Shelf

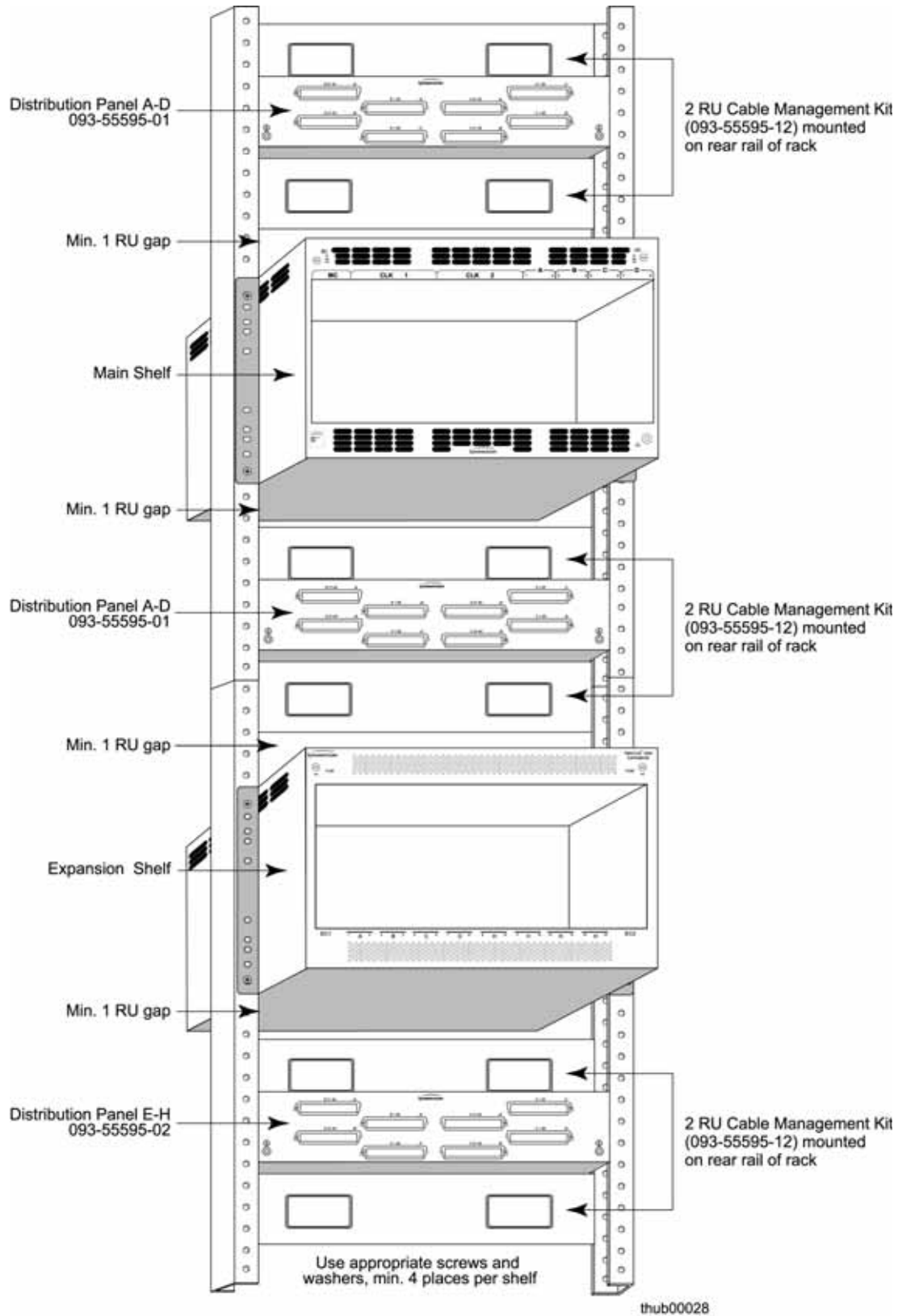

Figure 3-5. Sample Rack Installation of a Master and Expansion Shelf

Configuring the Shelf as a Master or Remote

You can configure the TimeHub shelf for either Master or Remote operation by setting a switch on the backplane. The shelf and all plug-in cards are compatible with either mode of operation. [Master/Remote Shelf](#), on page 32, describes the Master and Remote operating modes. The TimeHub 5500 shelf is delivered from the factory configured as a Master.



Note: Management cards (090-55542-01) and Clock cards (090-55512-0x, 090-55514-0x) with firmware versions 4109x do not support Remote shelves. Issue the TL1 command RTRV-NETTYPE-ALL to retrieve the firmware version (see the TimeHub 5500 *TL1 Reference Manual* for detailed information about this command). If this firmware version is in your Management or Clock cards and you are interested in Remote shelf operation, contact Symmetricom Global Services for information about firmware upgrades.

SW1 (shown in [Figure 3-6](#)) determines the shelf configuration. The switch is located on the backplane behind the Management card slot.

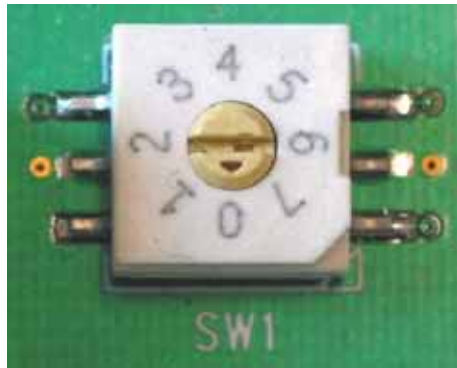

Figure 3-6. Master/Remote Rotary Switch

To configure the shelf for Remote operation:



Caution: To avoid a loss of timing signals, perform the following procedure only on a shelf with no active outputs. Do not remove the fuses from a shelf that is providing timing signals.

1. Disconnect power from the shelf by removing the fuses from the front panel or by disconnecting the wires from the power terminals on the rear panel of the shelf.
2. Remove the Management Card in order to obtain access to switch SW1. For improved access, you can also remove the CLK1 card from the shelf.

3. Set the switch as appropriate using an 8-inch (20 cm) long screwdriver with a 1/8-inch (3 mm) blade. A small arrow on the rotary switch indicates the selected setting. [Table 3-2](#) shows the function associated with the rotary switch settings.
 - For a Master shelf, set the switch to 0
 - For a Remote shelf, set the switch to 7
4. Replace the fuses to power up the shelf.

Table 3-2. Master/Remote Rotary Switch Settings and Functions

Rotary Switch Position	Function	Confirmation
0 (factory setting)	Configures the shelf as Master	Remote LED does <i>not</i> light following Warmup
1 – 6	Reserved for future use	–
7	Configures the shelf as Remote	Remote LED lights following Warmup

Making Ground and Power Connections

The TimeHub 5500 has redundant -48VDC power input connections labeled A and B. Both are located in the upper-right and upper-left corners of the rear panel, as shown in [Figure 3-7](#).

Grounding the Shelf

Frame ground connections are made on power terminal blocks TB1 and TB2 on the rear panel of the shelf. [Figure 3-7](#) illustrates the terminal connections.

1. Run a cable from each ground terminal to earth ground. Use one 16 AWG green insulated wire to connect the ground terminal of TB1 to the frame ground. Use another 16 AWG green insulated wire to connect the ground terminal of TB2 to frame ground.
2. Crimp the supplied spade lug to one end of the 16 AWG wire and connect it to the ground terminals on TB1 and TB2 ([Figure 3-7](#)).
3. Complete the ground connection using one of the methods described below, depending on whether a ground rod is installed in the rack.
4. Using a digital voltmeter, measure between the ground and chassis and verify that no voltage exists between them.

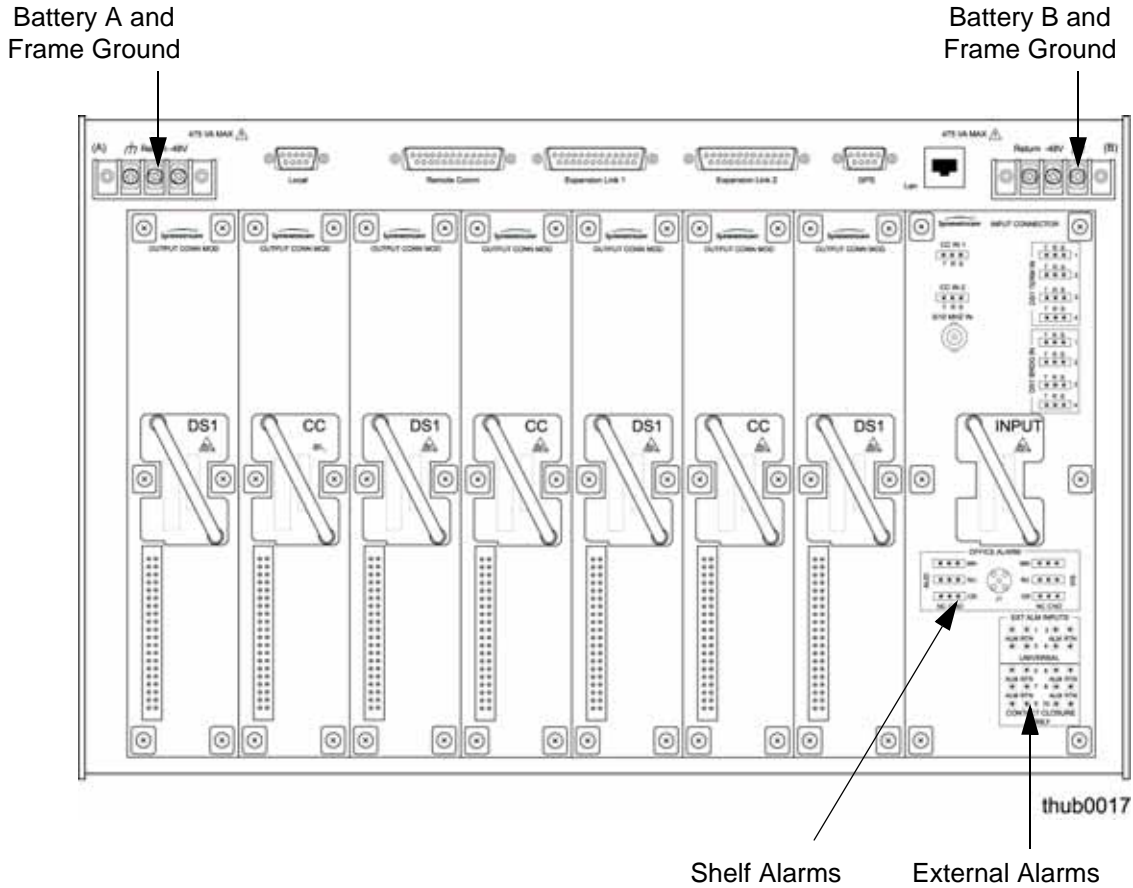

Figure 3-7. Connectors on the Rear Panel of the Master Shelf

With Ground Rod

Solder each 16 AWG ground wire to the 6 AWG frame ground rod that is run vertically on each side of the rack, if provided. Two methods are acceptable:

- Crimp an appropriate-size spade lug to the 16 AWG wire, bend the lug around the 6 AWG rod, and solder.
- Strip enough insulation from the 16 AWG wire to permit three complete turns around the 6 AWG rod and solder.



Note: Use an appropriate soldering iron to ensure the 6 AWG rod is heated sufficiently to prevent a cold solder connection.

Without Ground Rod

Crimp the supplied spade lug to the 16 AWG wire, and screw the lug to a screw hole on the rack. Remove the paint and sand the area around the screw hole to ensure proper conductivity. Coat the connection with an electrically conductive antioxidant compound such as Kopr-Shield spray.

Grounding the Wire-wrap Panel

The Wire-wrap panel delivered with the TimeHub shelf has two ground terminals on the front panel. Connect each of these two terminals to ground as described in this section.



Note: If you are using an existing wire-wrap panel, leave the wire-wrap panel ground connection intact.

1. Run a cable from each ground terminal to earth ground. Use one 16 AWG green insulated wire to connect each ground terminal to the frame ground.
2. Crimp the supplied spade lug to one end of the 16 AWG wire and connect it to the ground terminals on the front panel of the wire-wrap panel (Figure 3-8).
3. Complete the ground connection using one of the methods described above, depending on whether a ground rod is installed in the rack.
4. Using a digital voltmeter, measure between the ground and chassis and verify that no voltage exists between them.

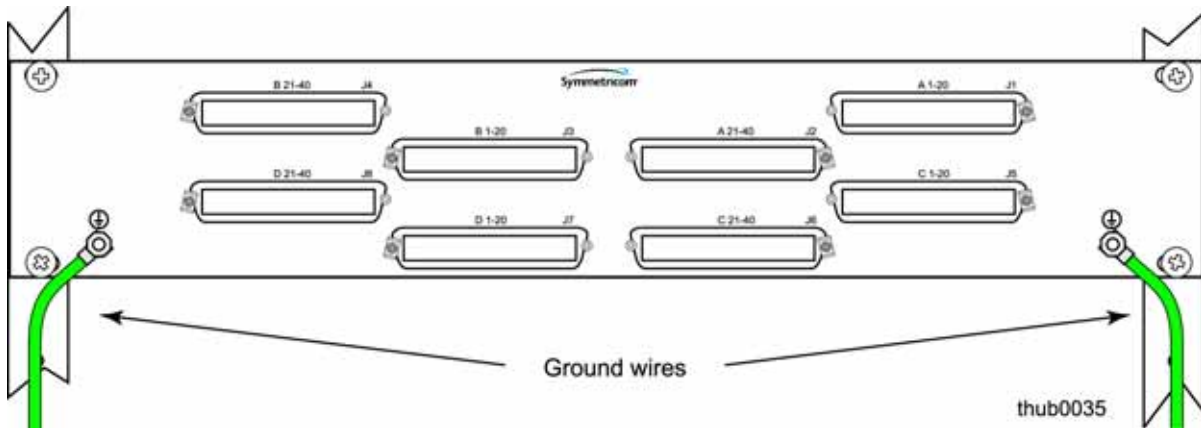

Figure 3-8. Wire-wrap Panel Ground Connection

Making Power Connections

Connect power leads to the shelf using the following procedure, but do not apply power at this time.



Warning: To avoid possible damage to equipment, you must provide power source protective fusing as part of the installation. The TimeHub is intended for installation in a restricted access location.



Caution: To avoid damage to the shelf, remove the fuses in the fuse panel which powers the TimeHub 5500 Shelf before you make power connections. Also make sure to remove the fuses from the TimeHub 5500 shelf before connecting power.

1. Remove both fuses from the front panel of the shelf. You will replace them at the end of the installation procedure.
2. Locate the power terminal blocks on the rear panel (Figure 3-9).

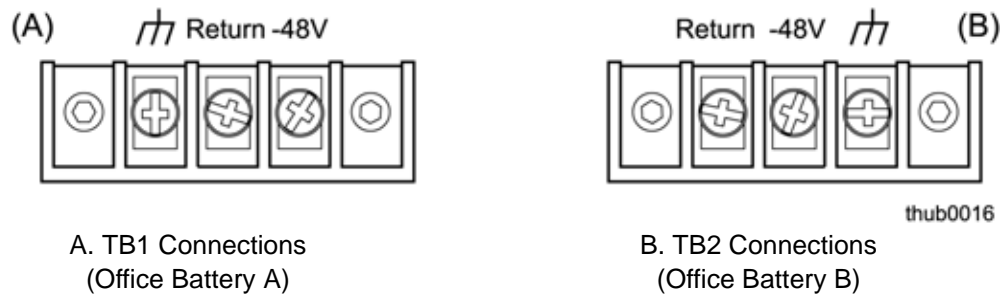

Figure 3-9. Power and Ground Connections on the Master Shelf

3. Using 18 AWG (minimum) stranded wire, connect primary power to the A terminal screws and secondary power to the B terminal screws. Symmetricom recommends that you use a #6 spade lug termination for each power lead. If separate power supplies are not available, connect both A and B power from the same source.

Use 10 A fuses in the source that supplies power to the TimeHub 5500 shelf.

Testing Power Connections

To verify that the power connections to the TimeHub 5500 Main shelf are correct, follow the steps in this section. Use a digital multimeter (Fluke 77 or equivalent) to make the measurements. Refer to Figure 3-7, Figure 3-9, and Figure 3-18. Use this procedure for Master/Remote and Expansion shelves.

1. Remove all fuses that supply power to the shelf from the fuse panel and from the front of the shelf.
2. Ensure that no Clock, Management, or Output Driver cards are installed in the shelf.
3. Disconnect the -48V battery A and battery B leads from the shelf power terminal blocks TB1 and TB2 (Figure 3-9 and Figure 3-18). (Leave the Return battery leads connected to the shelf.)

4. At the shelf end of the battery leads, use the multimeter to measure the voltage between the following test points:

Test Point	Test Point	Result
Battery A lead	Battery B lead	0 V
Battery A lead	TB1: Return A	0 V
Battery A lead	TB1: Ground	0 V
Battery B lead	TB2: Return B	0 V
Battery B lead	TB2: Ground	0 V

5. Reconnect the –48V battery A and battery B leads to the power terminal blocks (TB1 and TB2) –48V A and –48V B terminals.
6. Install the A fuse in the power source fuse panel.
7. Measure the voltage between the –48V A and Return terminals on the TB1 terminal block. The multimeter should indicate –42V dc to –56V dc.
8. Install the B fuse in the power source fuse panel.
9. Measure the voltage between the –48V B and Return terminals on the TB2 terminal block. The multimeter should indicate –42V dc to –56V dc.
10. Install both 3AG 10 A fuses (fuse A and fuse B) in the front of the shelf. The shelf is now powered up.

Installing Modules into the Rear Panel

This section describes how to install the Output Connector and Input/Alarm Connector modules into the rear panel of the shelf. Perform these procedures after you have installed the shelf into the rack. The procedures for installing modules into the front panel are described in [Installing Cards into the Front Panel](#), on page 104.

Installing Rear Panel Modules

You install Output Connector modules and the Input/Alarm Connector module on the rear panel of the shelf, as shown in [Figure 3-10](#).

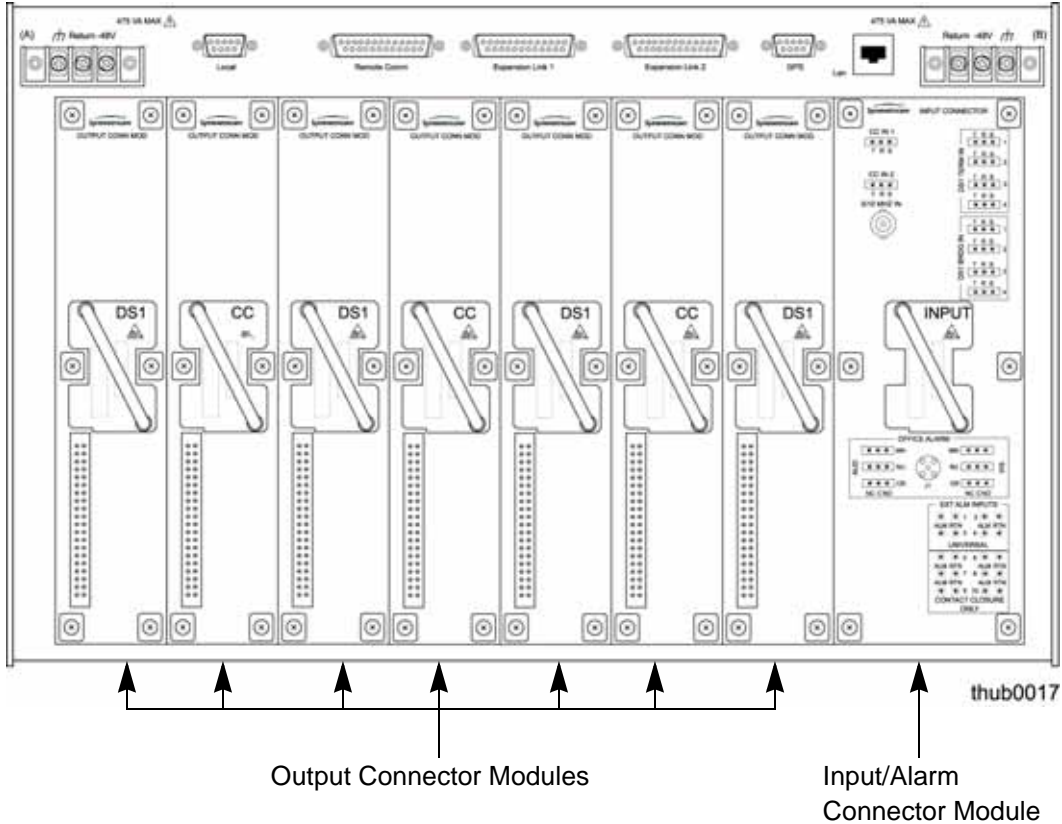

Figure 3-10. Location of Output Connector Modules on the Rear Panel of the Master/Remote Shelf

Installing the Input/Alarm Connector Module

The Input/Alarm Connector module (part number 090-55561-01) mounts on the rightmost position on the rear panel of a Master or Remote shelf (see [Figure 3-10](#)). The module is shown in [Figure 2-5](#). Expansion shelves do not use an Input/Alarm Connector module.

To install the module, align the pins on the rear of the module with the connector on the shelf. Carefully seat the module onto the shelf. Tighten the six captive screws to complete the installation.

Installing Output Connector Modules

You can install up to seven Output Connector modules in any of the locations on the rear panel of a Master or Remote shelf (see [Figure 3-10](#)). The Output Connector module determines the type of output signal generated. Each Output Connector module provides connections for 20 signals from the Output Driver cards. The Output Connector modules for a Master/Remote shelf cannot be used on an Expansion shelf.

Master and Remote Shelves

For DS1 outputs, use DS1 Output Connector modules (part number 090-55591-01), which are part of the DS1 Output Connector Module Kit (990-55591-01).

For CC outputs, use CC Output Connector modules (part number 090-55593-01), which are part of the CC Output Connector Module Kit (990-55593-01).

To install the Output Connector module, align the pins on the rear of the module with the connector on the shelf. Carefully seat the module onto the shelf. Tighten the six captive screws to complete the installation.



Note: A label and the handle on each Master/Remote Output Connector module denotes the type of output signal it generates. Each DS1 Output Connector module is labeled “DS1” and has a black handle; each CC Output Connector module is labeled “CC” and has a blue handle.

Expansion Shelves

You can install up to 16 Output Connector panels in any of the locations on the rear panel of an Expansion shelf, as shown in [Figure 3-11](#). The Output Connector module determines the type of output signal generated. Each Output Connector module provides connections for 20 signals from the Output Driver cards. The Output Connector modules for an Expansion shelf cannot be used on a Master/Remote shelf.

For DS1 outputs, use Output Connector module p/n 090-55591-02, which is part of the DS1 Output Module Kit (990-55591-02).

For CC outputs, use Output Connector module p/n 090-55593-02, which is part of the CC Output Module Kit (990-55591-02).



Note: The part number label on each Expansion Output Connector module denotes the type of output signal it generates. Each module may also have silk-screened text denoting the output signal it generates.

To install the Output Connector module on an Expansion shelf, align the pins on the rear of the module with the connector on the shelf. The vertical connector should be facing to the left and the small connector should be on the bottom facing towards the mating connector on the shelf. Carefully seat the module onto the shelf. Tighten the captive screws to complete the installation.

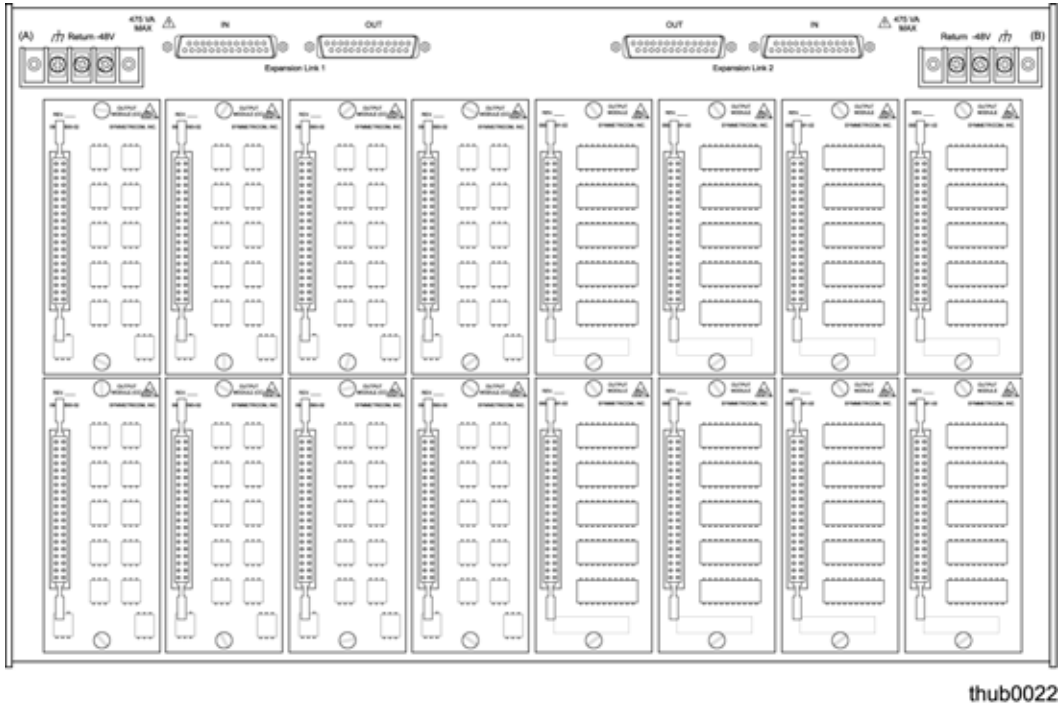

Figure 3-11. Location of Output Connector Modules on the Rear Panel of the Expansion Shelf

Installing Blank Panels

Install blank panels over each slot that is unused. The blank panel protects the connector, provides EMC shielding, and maintains efficient cooling airflow within the shelf.

Input/Clock Blank Panels (Master and Remote Shelf Only)

If you install only one Input/clock card, then install the blank panel (090-55598-01) in the empty slot space reserved for the second card.

Output Driver Blank Panels (All Shelves)

Install a blank panel (093-55598-02) in empty slots where Output Driver cards are not installed.

Output Connector Module Blank Panels (Master and Remote Shelf Only)

The blank panel (p/n 093-55599-01) can be used only in a Master/Remote shelf.

Install blank panels in the spaces where no Output Connector modules are installed.

Output Connector Module Blank Panels (Expansion Shelf Only)

There are two types of Output Connector module blank panels for the Expansion shelf:

- The blank panel p/n 093-55599-02 is a single height blank panel. It covers only one Output Connector module space.
- The blank panel p/n 093-55599-03 is a double-height blank panel. It covers a complete output group, including both Output Connector module spaces.

Install the desired Output Connector module blank panels in the back of the Expansion shelf.

Making Signal Connections

After you install the shelf in the rack, you need to make the following types of signal connections:

- Shelf to connection panel
- Timing inputs
- Communications
- Alarms

[Figure 3-12](#) shows the power, timing input, and communication port connectors on the rear panel of the shelf.

If you are not installing an Expansion shelf, you do not need to install a Termination Connector (090-555xx-0x) on both Expansion Link 1 and Expansion Link 2 on the rear panel of the shelf.

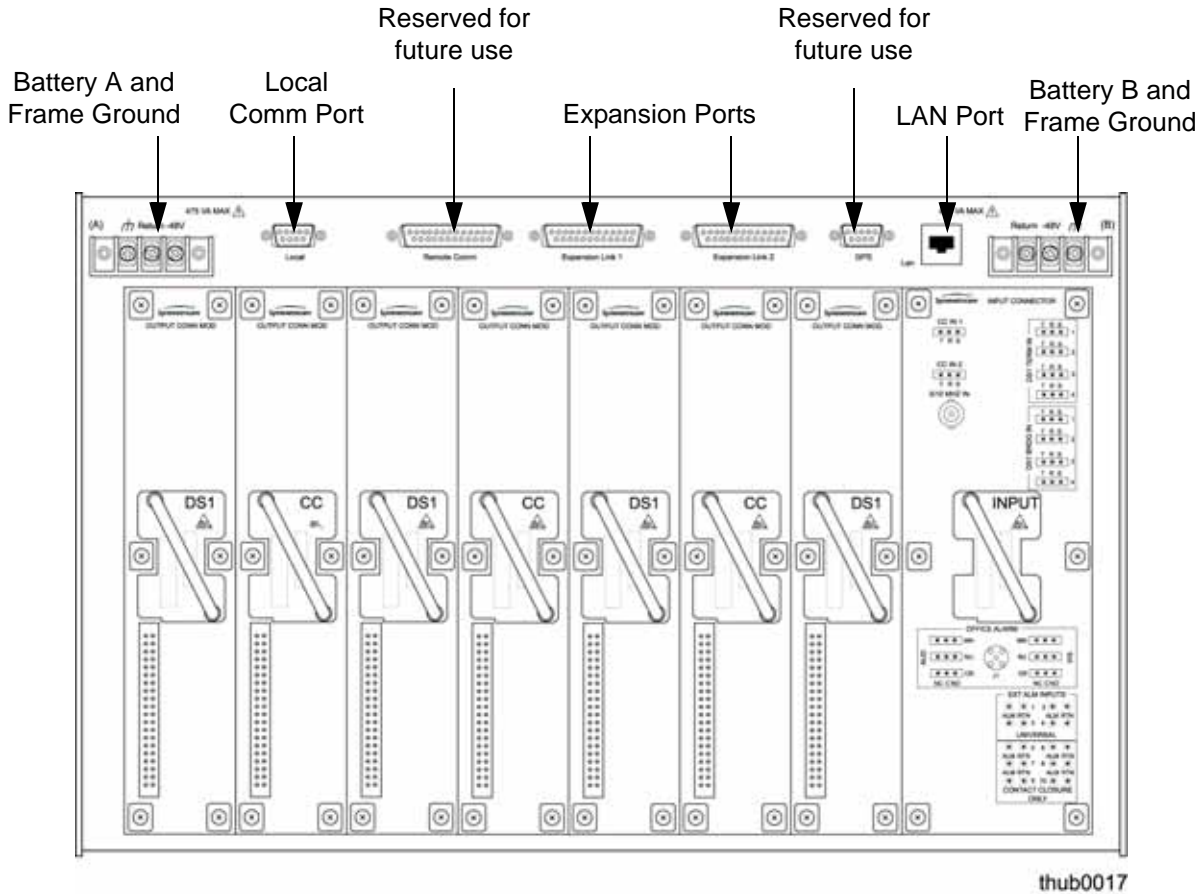

Figure 3-12. Rear Panel Connectors on the Main Shelf

Making Shelf-to-Panel Connections

Connect the factory-supplied cable from the connector on the Output Connector card on the rear panel of the shelf to the appropriate connector on the wire-wrap panel. Repeat as needed, depending on the number of outputs used. Refer to [Figure 3-13](#).



Note: The shield drain conductor is provided to ground to the rack frame ground at the wire-wrap connector end. Symmetricom does not recommend that you ground the shield at both ends.

If the timing lead is connected to a Network Element with an isolated ground configuration, then terminate the shield wire at the Network Element.

Dress the cables using your company standards.

To maximize the number of timing leads that you can terminate on the High-Density Wire-wrap Panel, Symmetricom recommends that you cut back the sheathing on the cable such that only the Tip, Ring, and insulated Shield conductors enter the cable management kit. Removing up to 24 inches (61 cm) of shielding will have little or no effect on the stability of the timing signals.

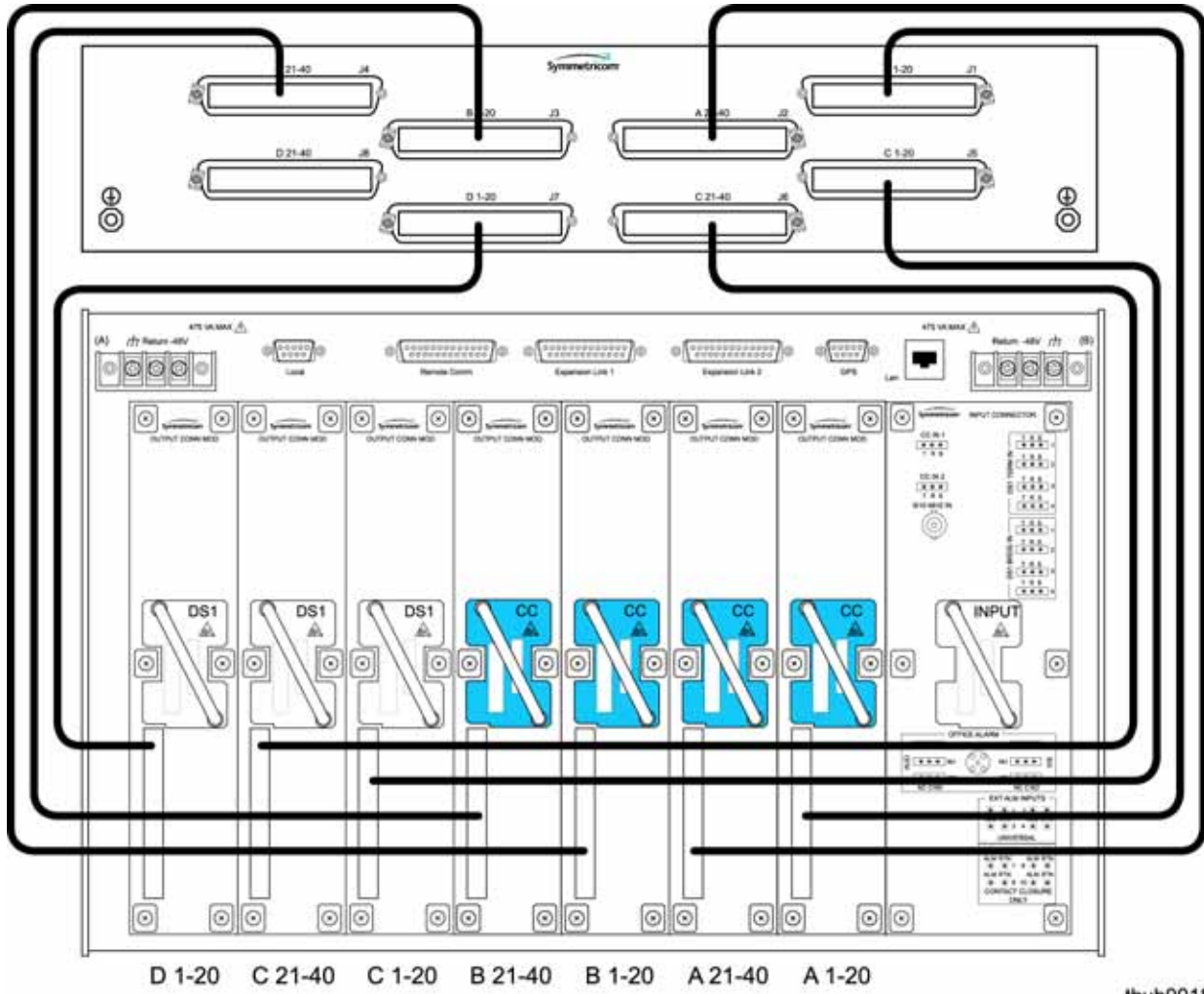
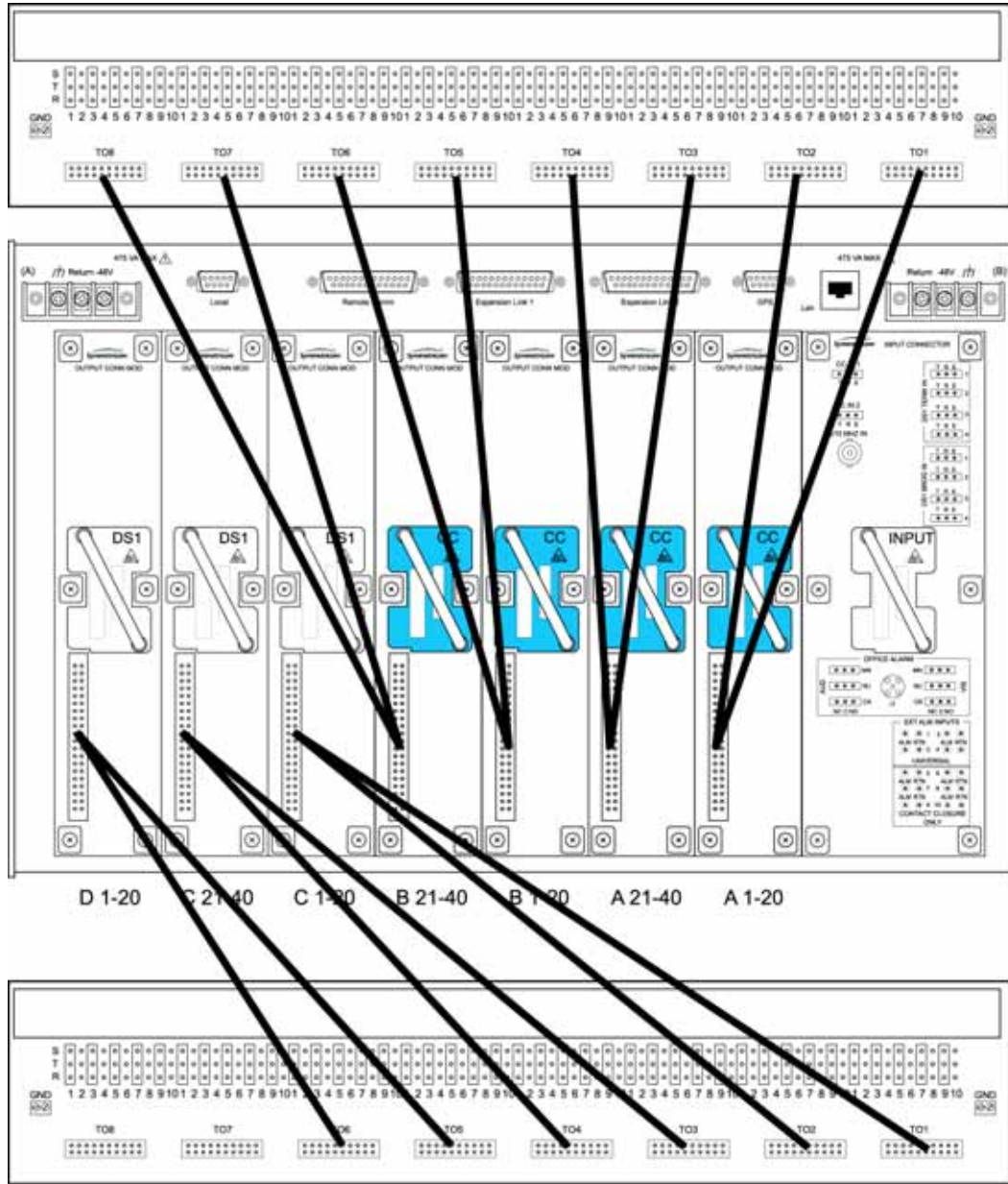

Figure 3-13. Connecting Outputs to the High-Density Wire-wrap Panel

Figure 3-14 illustrates how to connect the TimeHub to existing wire-wrap panels used with a DCD-5XX shelf.



thub0060

Figure 3-14. Connecting Outputs to Existing Wire-wrap Panels

Figure 3-15 and Figure 3-16 illustrate how to connect the A through D and E through H outputs from the TimeHub Expansion shelf to the High-Density Wire-wrap Panel, respectively. The diagrams illustrate suggested cable routing using the optional Cable Management trays.

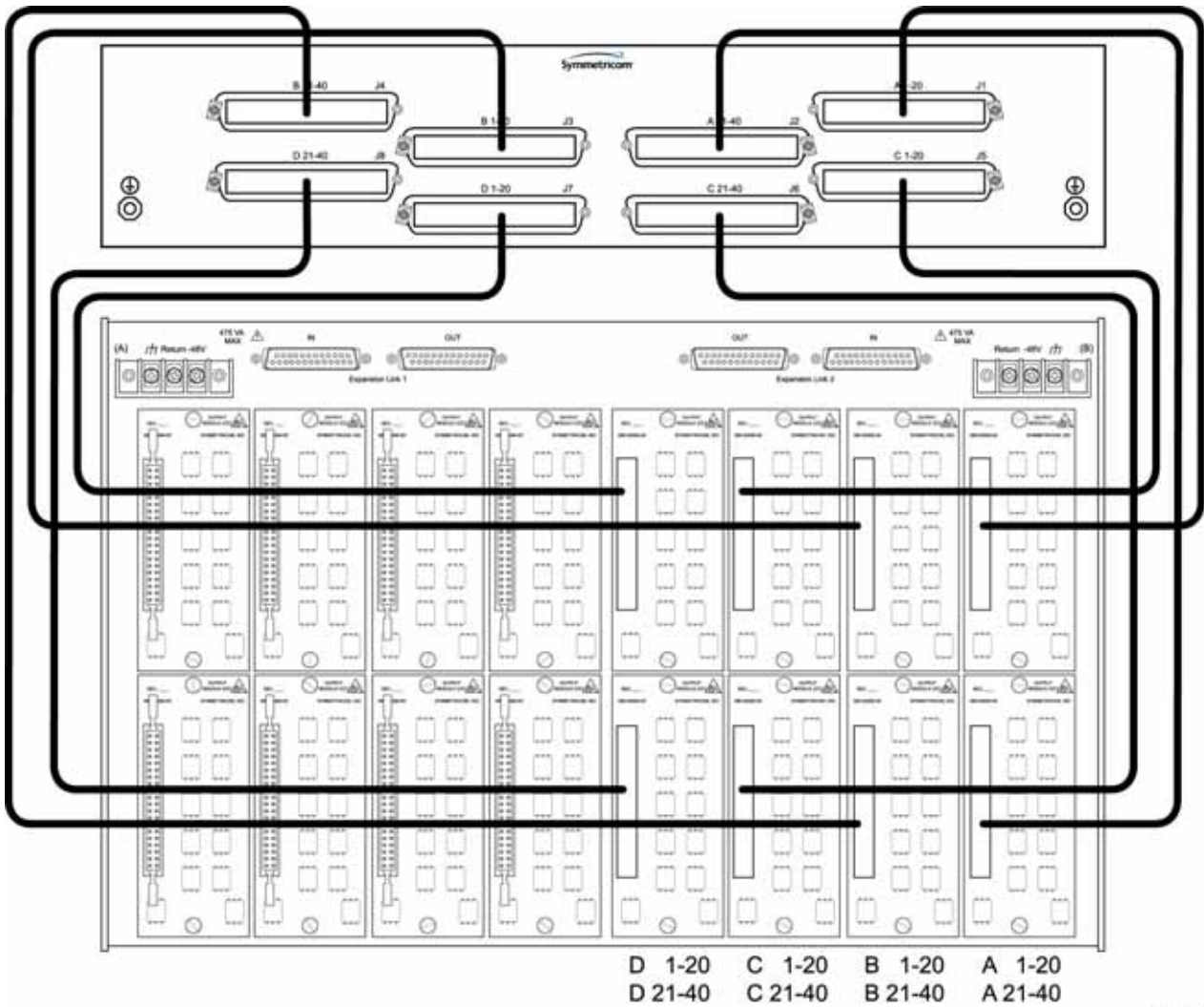

thub0061

Figure 3-15. Connecting A-D Outputs of the Expansion Shelf to the High-Density Wire-wrap Panel

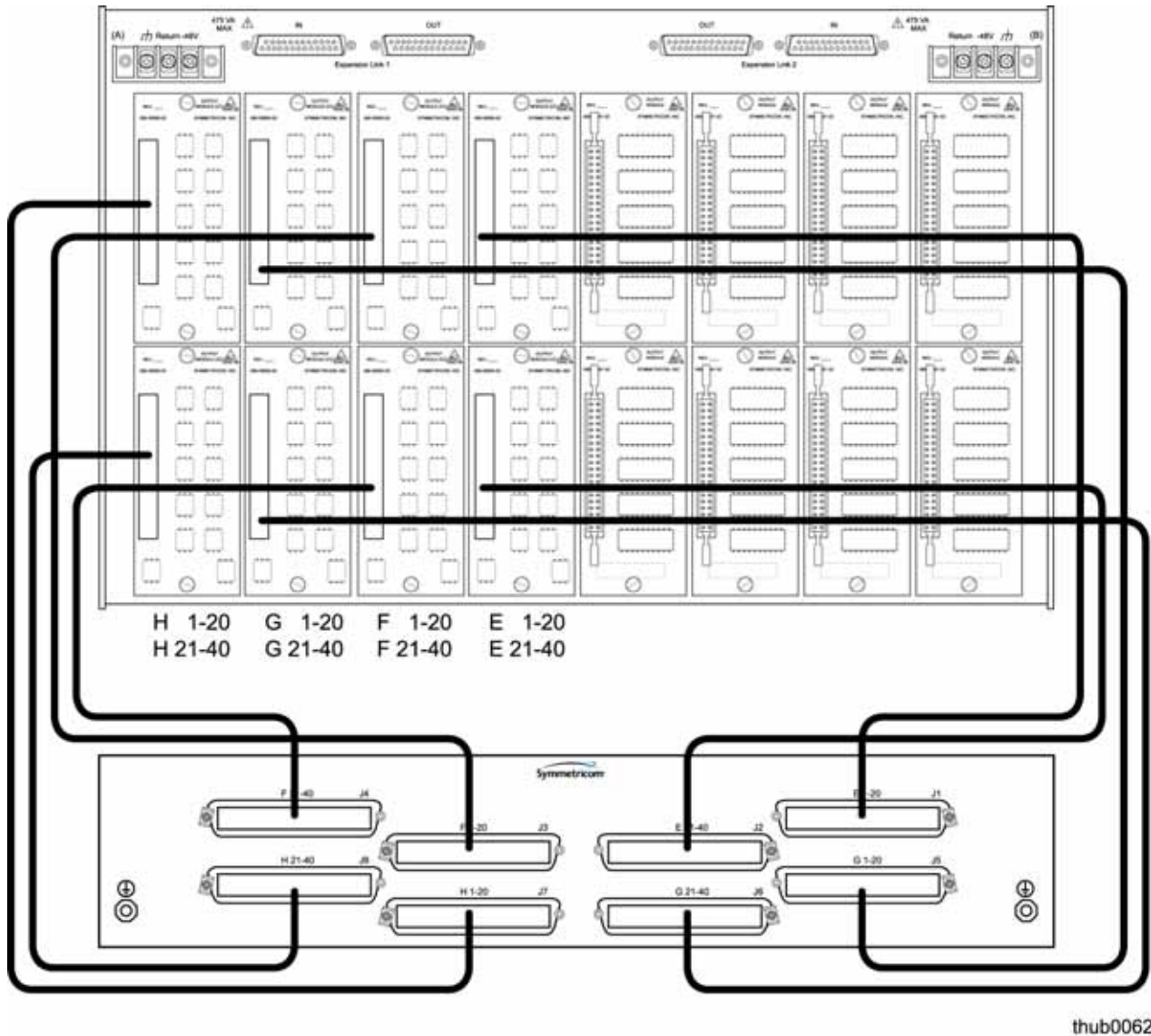

thub0062

Figure 3-16. Connecting E-H Outputs of the Expansion Shelf to the High-Density Wire-wrap Panel

Connecting Timing Inputs

You make all timing input connections on the Input/Alarm Connector module (Figure 3-17). Install the module as described in [Installing the Input/Alarm Connector Module](#), on page 78.

DS1 Reference

You can connect up to four DS1 reference inputs to the TimeHub 5500; use the wire-wrap pins labeled DS1 TERM IN on the Input/Alarm Connector module. Connect the tip wire to the pins labeled T, the ring wire to the pins labeled R, and the shield (if connected at the TimeHub 5500) to the pins labeled S.

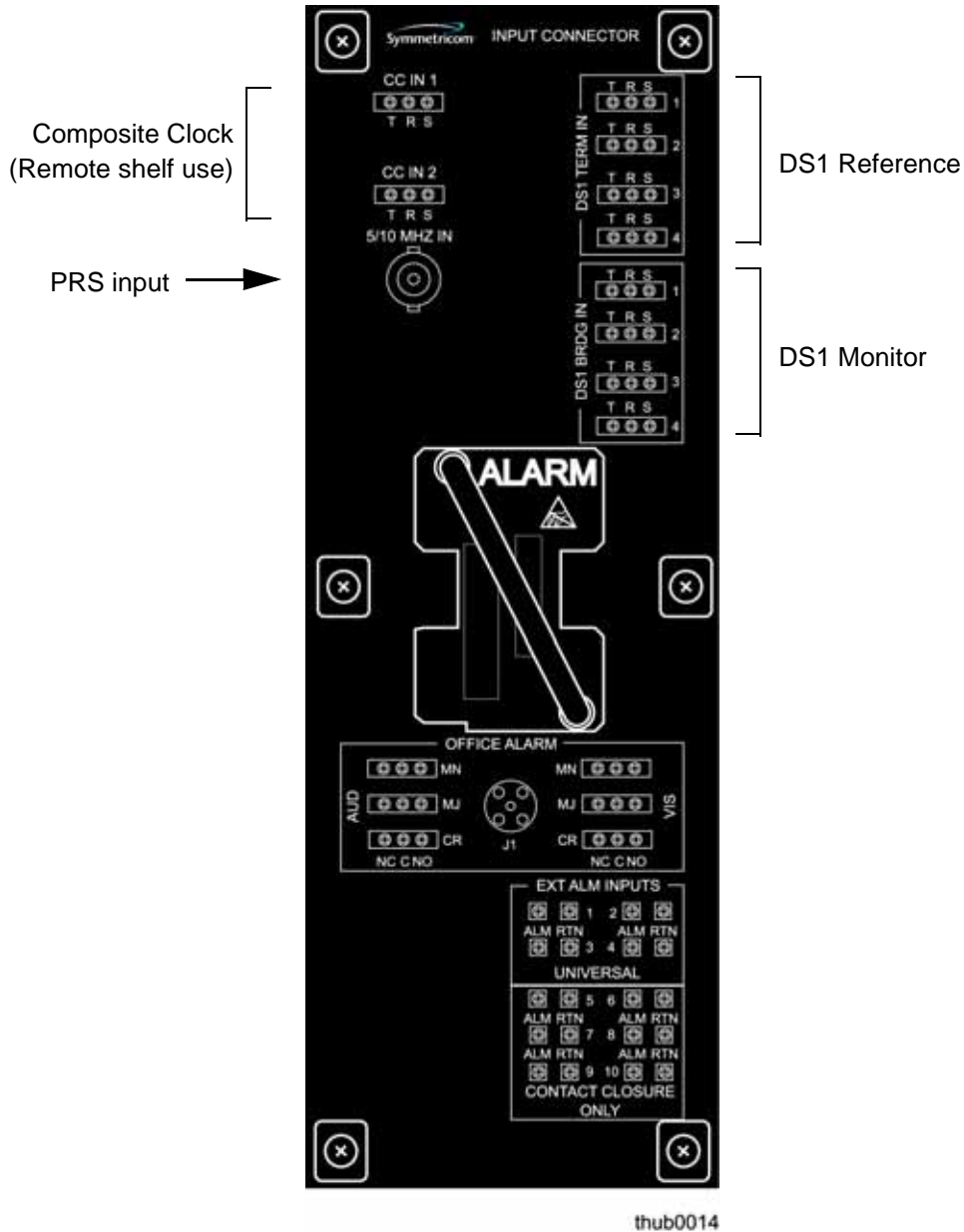

Figure 3-17. Input/Alarm Connector Module Connections

DS1 Monitor

You can connect up to four additional DS1 inputs using the DS1 BRIDG IN pins on the Input/Alarm Connector module only when you install nine-input Clock cards (090-55512-02 or 090-55514-02). Connect the tip wire to the pins labeled T, the ring wire to the pins labeled R, and the shield (if connected at the TimeHub 5500) to the pins labeled S.

PRS Input

Connect the PRS input to the BNC connector labeled 5/10 MHz IN on the Input/Alarm Connector module.

CC Input

You can connect one or two Composite Clock (CC) inputs when you configure the shelf for Remote operation (see [Configuring the Shelf as a Master or Remote](#), on page 72). Connect the tip wire to the pins on the Input/Alarm Connector module labeled T, the ring wire to the pins labeled R, and the shield (if connected at the TimeHub 5500) to the pins labeled S.

Making Communication Connections

Connecting a LAN Cable

Connect the LAN cable from the network to the RJ-45 (10Base-T) connector labeled LAN on the rear of the shelf. Refer to [Figure 3-12](#) for the connector location; [Table 3-3](#) describes the connector pinout.

Each TimeHub 5500 has its own IP address that can be set through the local RS-232 port, as described in [Communicating by Ethernet](#), on page 116. Once the IP address has been set and a LAN connection made, the TimeHub 5500 can be remotely accessed on a network.

Table 3-3. LAN Connector Pinouts

Pin	Signal	Abbreviation	Direction
1	Transmit data +	TXD +	From TimeHub 5500
2	Transmit data –	TXD –	From TimeHub 5500
3	Receive data +	RXD +	To TimeHub 5500
6	Receive data –	RXD –	To TimeHub 5500

Note: Pins not listed are reserved for future use.

Connecting a Local Serial Cable

The Local connector on the rear panel of the TimeHub 5500 provides a 9-pin RS-232 link for TL1 command access. See [Figure 3-12](#) for the location of the connector and [Table 3-4](#) for the connector pinouts. The Local communication port on the front panel of the Management card provides the same function as the Local communication port on the rear of the shelf.



Note: You cannot make connections to both of the Local ports simultaneously; only one port can be used at a time.

Table 3-4. Pinout of Local Communications Port

Pin	Signal	Abbreviation	Direction
2	Transmit data	TXD	From TimeHub 5500
3	Receive data	RXD	To TimeHub 5500
5	Signal ground	GND	–
7	Clear to send	CTS	To TimeHub 5500
8	Request to send	RTS	From TimeHub 5500

Note: Pins not listed are reserved for future use.

The TimeHub 5500 is wired as a DTE device; use a null-modem cable to connect a laptop. Use a straight-through cable to connect a modem to this port. The default port settings are 9600 baud, no parity, 8 data bits, 1 stop bit, echo on, and handshaking disabled.

Connecting Alarms

You can make three types of alarm connections to the Input/Alarm Connector module: Office, External, and Universal. Two sets of office alarm connections allow you to signal minor, major, and critical error conditions within the TimeHub 5500. External and universal alarms allow you to connect alarms from other equipment.

You can also monitor alarms using the TimeScan THC software. Alarms are transmitted over the serial or Ethernet communications port; you do not have to make any alarm connections on the Input/Alarm Connector module.

The Alarm Cutoff pushbutton on the front panel of the Management card de-activates alarm output on all of the audible (AUD) alarm wire-wrap pins. When an alarm occurs, the appropriate alarm LED lights on the front panel of the Management card. The alarm is asserted on the appropriate AUD and VIS wire-wrap pins. Pressing the cutoff pushbutton for approximately 10 s de-asserts the alarm on the AUD pins and the cutoff LED will light (indicating that audible alarms have been cut off). Any alarm asserted on the VIS wire-wrap pins is unaffected by the cutoff pushbutton. The alarm LED and cutoff LED will remain lit until the condition causing the alarm is no longer present. Should new alarms occur later, the AUD alarm will activate again.



Note: If simultaneously-occurring alarms have different severity levels, only the alarm with the highest severity appears on the front panel LEDs if the alarms are both either in the “System” or “Shelf” category. For example, if there are both MAJOR and MINOR shelf alarms present, only the MAJOR alarm LED is lit in the “Shelf” alarm row. In this case, if the MAJOR alarm ends, then the MINOR alarm LED will light (assuming that the source of that alarm is still present) since this is now the highest severity alarm.

It is possible to have alarm LEDs of different severity illuminated if one is a shelf alarm and the other a system alarm. If there is a MAJOR shelf alarm and a MINOR system alarm (any of the external alarms in 7 to 10 range), then the MAJOR LED is lit for the shelf alarm row and the MINOR LED is lit for the system alarm row.

Connecting Office Alarms

The Office alarms provide normally-open, center, and normally-closed contact pins. You connect the office alarms to the OFFICE ALARM critical (CR), major (MJ), and minor (MN) wire-wrap pins on the Input/Alarm Connector module. See [Figure 3-17](#) for the location of the pins.

Use the AUD pins on the left for audible alarms and the VIS pins on the right for visible alarms. Connect the alarm circuit between the NO and C pins for normally open contacts, or between the NC and C pins for normally closed contacts. If required, use the pins (VIS) on the right to connect to remote telemetry equipment.

Perform the following steps to ensure proper alarm connections to the TimeHub 5500.

1. Ensure that both fuses are removed from the front panel.
2. Locate the OFFICE ALARM critical (CR), major (MJ), and minor (MN) wire-wrap pins on the Input/Alarm Connector module.
3. Connect office alarms to the wire-wrap terminals.
4. Verify that correct wiring connections have been made.
5. Reinstall both fuses.



Note: In an alarm condition or loss of DC power, the contact between the NO and COM closes and the contact between the NC and COM opens.

Connecting External Alarms

Connect the external alarm inputs (customer-configured alarm inputs) to RACK ALM INPUTS wire-wrap pins 1 through 10 on the Input/Alarm Connector module. See [Figure 3-17](#) for the location of the pins.

The external alarm inputs allow the TimeHub 5500 to accept alarms from external equipment. When an alarm is accepted:

- an alarm LED lights in the “system” row on the Management card
- the appropriate alarm output wire-wrap pins (AUD and VIS) activate on the Alarm Connector card
- an automatic message appears on the Local and LAN communications ports (see [Management Card](#), on page 24), notifying a remote management system of the external alarm condition.

There are two types of external alarm inputs: contact closure only and universal.

Contact Closure Only External Alarms

These six sets of alarm inputs (5-10) operate from any relay contact closure. Severity levels associated with these alarm inputs are:

- MAJOR: inputs 5 and 6
- MINOR: inputs 7-10

Universal External Alarms

These four sets of alarms operate from any relay contact closure. They are also capable of accepting alarms produced by a source transition to and from -48 V. Transition from -48 V to 0 generates an alarm; transition from 0 to -48 V clears the alarm. Severity levels for the universal alarms are:

- MAJOR: inputs 1, 2
- MINOR: inputs 3, 4

GPS Input

The GPS connector is reserved for future use.

Installing the Cover

Fit the plastic cover over the rear of the shelf after you make all connections. Use the captive screws to attach it to each corner of the shelf.

Installing Expansion Shelves

The TimeHub 5500 has two interface connectors to connect an Expansion shelf. You can connect up to four Expansion shelves in a daisy-chain fashion using two Expansion Interface cables (060-55591-02) per shelf. You make the connection using the Expansion Link 1 and 2 connectors on the rear panel of the Main shelf.

Installing the Shelf in the Rack

Install the Expansion shelf using the procedure described in [Rack Mounting the TimeHub 5500](#), on page 67.

Making Ground and Power Connections

The Expansion shelf has redundant -48VDC power input connections labeled A and B. Both are located in the upper-right and upper-left corners of the rear panel; the connections are three-position terminal blocks, as shown in [Figure 3-18](#). The connections are *not* the same as on the Master shelf.

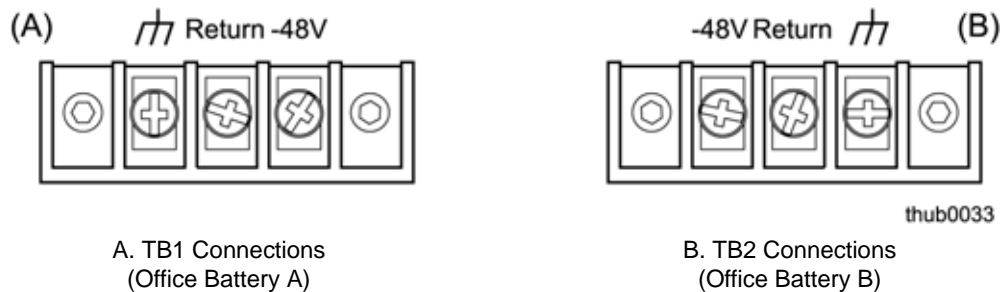

Figure 3-18. Power and Ground Connections on the Expansion Shelf

Install power and ground connections using the procedure described in [Making Ground and Power Connections](#), on page 73.



Warning: To avoid possible damage to the shelf and to the office power supply, connect power wiring as indicated on the rear of the Expansion shelf. The power connections on the Expansion shelf are *not* the same as on the Master shelf.

Setting the Expansion Shelf Address

You can install up to four Expansion shelves in a daisy-chain to a Master or Remote shelf. Each Expansion shelf requires a unique address. You set the address of the Expansion shelf using an eight-position rotary switch on the backplane ([Figure 3-19](#)). This switch is located near the bottom at the left side, behind the slot for Expansion Controller card 1 (labeled EC1). The factory default setting is “1”.

The address of the Expansion shelf connected to the Master or Remote shelf is always 1. The next Expansion shelf has an address of 2, and so on.



Caution: To avoid a loss of timing signals, perform the following procedure only on a shelf with no active outputs. Do not remove the fuses from a shelf that is providing timing signals.

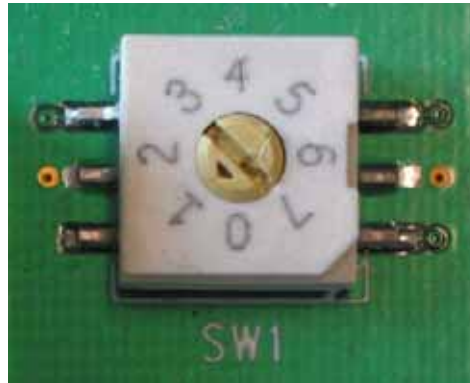

Figure 3-19. Address Switch SW1 on the Expansion Shelf

1. Disconnect power from the shelf by removing the fuses from the front panel or by disconnecting the wires from the power terminals on the rear panel of the shelf.
2. Remove the Expansion Controller card from slot EC1 (if it is installed) in order to obtain access to switch SW1. For improved access, you can also remove the adjacent Output Driver card from the shelf.
3. Set switch SW1 on the Expansion shelf as appropriate using an 8-inch (20 cm) long screwdriver with a 1/8-inch (3 mm) blade. A small arrow on the rotary switch identifies the selected setting. Table 3-5 shows the function associated with the rotary switch settings.

Table 3-5. Expansion Shelf Rotary Switch Settings and Functions

Rotary Switch Position	Function	Confirmation
1 (default) – 4	Sets a unique address for the Expansion shelf	TL1 responses originating from this shelf start with Sx, where x is the value of the rotary switch
All other positions	Reserved for future use	–

Installing Output Connector Modules

You can install up to 16 Output Connector panels in any of the locations on the rear panel of an Expansion shelf, as shown in [Figure 3-20](#). The Output Connector module determines the type of output signal generated. Each Output Connector module provides connections for 20 signals from the Output Driver cards. The Output Connector modules for an Expansion shelf cannot be used on a Master/Remote shelf.

For DS1 outputs, use connector module part number 090-55591-02, which is part of the DS1 Output Module Kit (990-55591-02).

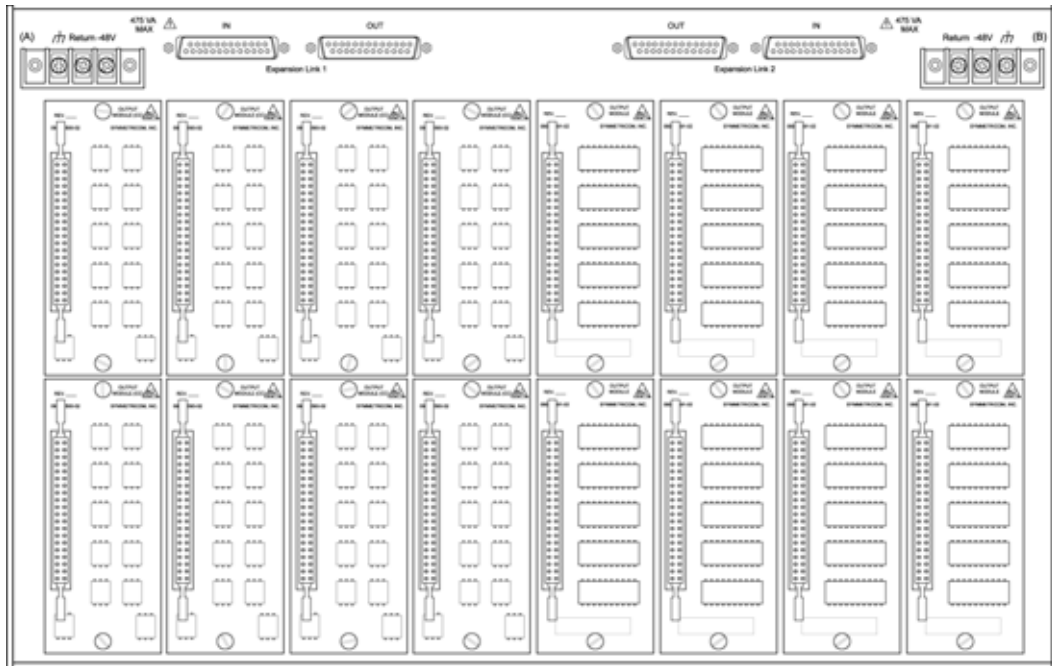

thub0022

H 1-20	G 1-20	F 1-20	E 1-20	D 1-20	C 1-20	B 1-20	A 1-20
H 21-40	G 21-40	F 21-40	E 21-40	D 21-40	C 21-40	B 21-40	A 21-40

Figure 3-20. Location of Output Connector Modules on the Rear Panel of the Master/Remote Shelf

For CC outputs, use connector module part number 090-55593-02, which is part of the CC Output Module Kit (990-55591-02).

To install the Output Connector module on an Expansion shelf, align the pins on the rear of the module with the connector on the shelf. The vertical connector should be facing to the left and the small connector should be on the bottom facing towards the mating connector on the shelf. Carefully seat the module onto the shelf. Tighten the captive screws to complete the installation.

Making Expansion Shelf Connections

Two cables provide timing and data to the Expansion shelf from either the Master shelf or to an upstream Expansion shelf. Two additional cables provide timing and data to a downstream Expansion shelf. This section describes the procedures to connect a single Expansion shelf and multiple Expansion shelves.

Connecting a Single Expansion Shelf

You make the connections on the rear panel of the Master and Expansion shelves, as shown in [Figure 3-21](#). You need two cables (060-55505-01), one gender changer (128-55505-01), and two Termination Connectors (090-55505-01), which are included with the Expansion shelf kit.

1. Connect one end of cable 060-55505-01 to the Expansion Link 1 connector on the rear panel of the Master shelf. The connectors are gender-coded to ensure correct installation.
2. Connect the other end of this cable to the Expansion Link 1 IN connector on the rear panel of the Expansion shelf.
3. Connect one end of the second 060-55505-01 cable to the Expansion Link 2 connector on the Master shelf.
4. Connect the other end of this cable to the Expansion Link 2 IN connector on the Expansion shelf.
5. Install a gender changer 128-55505-01 to the Expansion Link 2 OUT connector on the Expansion shelf.
6. Install the Termination Connectors on the Expansion Link 1 OUT and Expansion Link 2 OUT connectors.
7. Tighten all connections.

Connecting Multiple Expansion Shelves

You make the connections on the rear panel of the Master and Expansion shelves, as shown in [Figure 3-22](#). You need two cables (060-55505-01) for each Expansion shelf, one gender changer (128-55505-01), and two Termination Connectors (090-55505-01), which are included with the Expansion shelf kit.

1. Connect one end of cable 060-55505-01 to the Expansion Link 1 connector on the rear panel of the Master shelf. The connectors are gender-coded to ensure correct installation.
2. Connect the other end of this cable to the Expansion Link 1 IN connector on the rear panel of the first Expansion shelf.
3. Connect one end of a second cable 060-55505-01 to the Expansion Link 2 connector on the Master shelf.

4. Connect the other end of this cable to the Expansion Link 2 IN connector on the first Expansion shelf.
5. Connect one end of a third cable 060-55505-01 to the Expansion Link 1 OUT connector on the first Expansion shelf.
6. Connect the other end of this cable to the Expansion Link 1 IN connector on the second Expansion shelf.
7. Connect one end of a fourth cable 060-55505-01 to the Expansion Link 2 OUT connector on the first Expansion shelf.
8. Connect the other end of this cable to the Expansion Link 2 IN connector on the second Expansion shelf.
9. Repeat steps 5 through 8 for each additional Expansion shelf in the system.
10. Install a gender changer 128-55505-01 to the Expansion Link 2 OUT connector on the last Expansion shelf in the system.
11. Install the Termination Connectors on the Expansion Link 1 OUT and Expansion Link 2 OUT connectors on the last Expansion shelf in the system.
12. Tighten all connections.

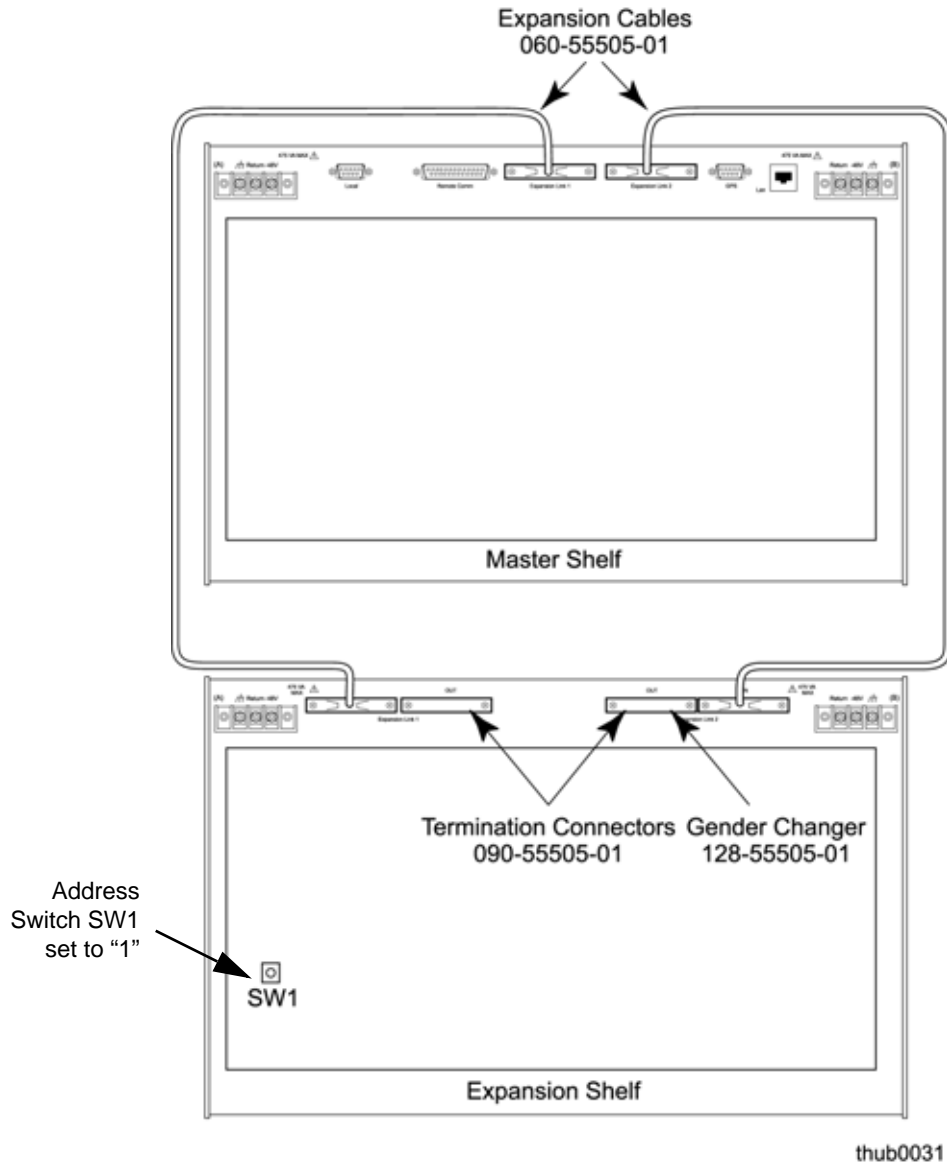

Figure 3-21. Connecting a Single Expansion Shelf

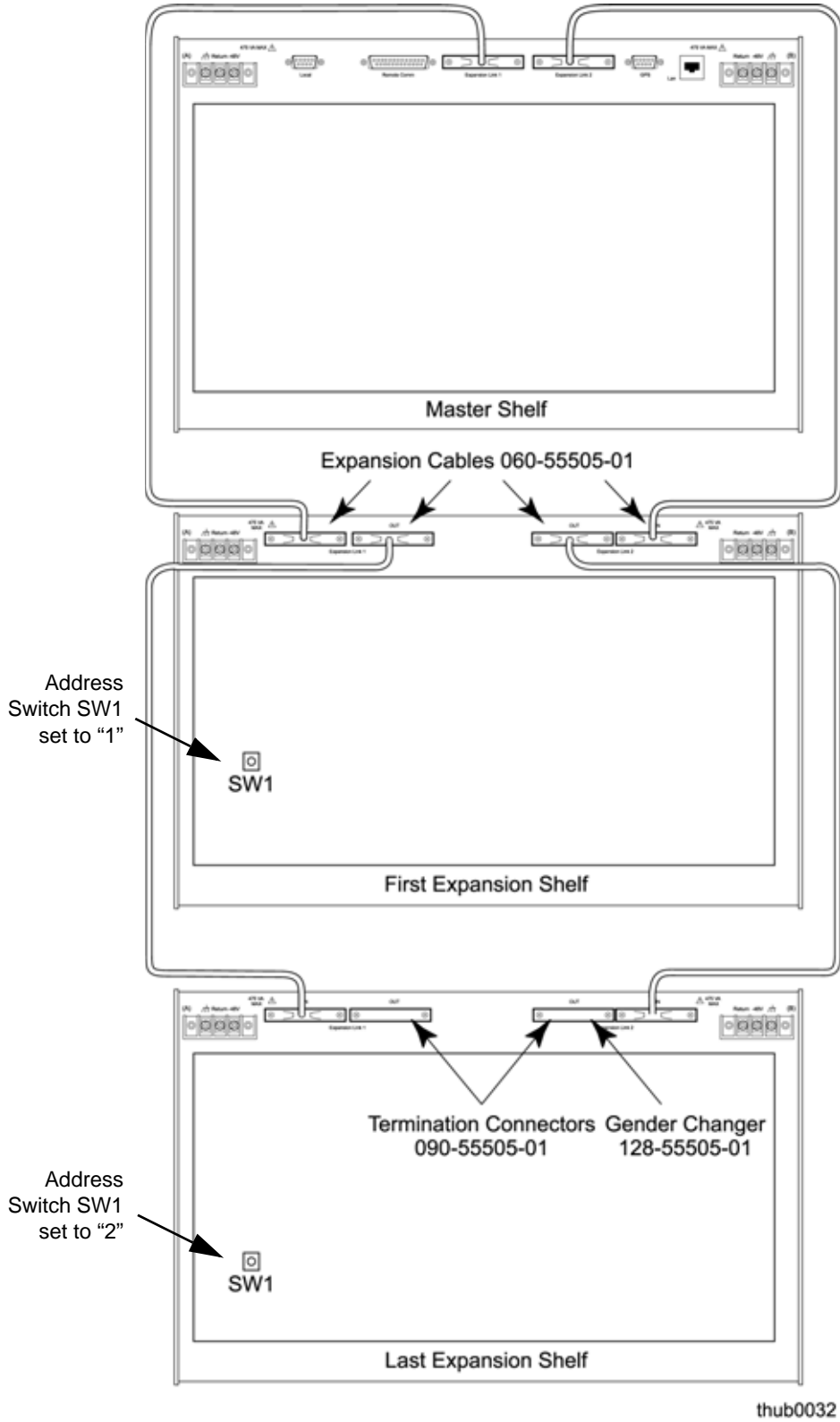

Figure 3-22. Connecting Multiple Expansion Shelves

Verifying the Installation

Perform the following procedure to verify the operation of the expansion shelf:

1. Establish either a serial or Ethernet communications connection to the TimeHub 5500.
2. Enter the command `RTRV-NETTYPE-ALL` (as shown in the following example) and verify that the expansion shelf's current hardware configuration is listed in the response.



Note: The active clock may take from three to ten minutes to do a complete inventory depending on the number of expansion shelves present.

Command Example:

Issue the following TL1 command:

```
RTRV-NETTYPE-ALL;
```

Or, using TimeScan THC:

1. Select **Mode, Command Response** from the main menu to open the Command Response window.
2. Select **TL1Commands, RTRV-NETTYPE-ALL**, or press **F2** to send the `RTRV-NETTYPE-ALL` query.

A typical response is as follows:

```
SYMMBITS 04-10-19 11:14:33
M SV36 RTRV
  "TSG:Symmetricon,5500,TSG"
  "S0-IMC:,090-55542-01-A,,R4209C,J86746,D0TPN0NAAA,106063"
  "S0-CLK1:,090-55514-02-A,,R4142B,J63939,D0TPKRJAAA,297083"
  "S0-CLK2:,090-55512-02-A,,R4312A,K60716,D0TPVRKAAA,299460"
  "S0-OUT1A:,090-55581-01-A,,R4236A,00M15316,D0TPJNMAAA,105045,CC,"
  "S0-OUT2A:,090-55581-01-A,,R4236A,00M15320,D0TPJNMAAA,105045,CC,"
  "S0-OUT3B:,090-55581-01-A,,R4236A,00M15317,D0TPJNMAAA,105045,CC,"
  "S0-OUT4B:,090-55581-01-A,,R4236A,00M15360,D0TPJNMAAA,105045,CC,"
  "S0-OUT5C:,090-55581-01-A,,R4236A,00M15358,D0TPJNMAAA,105045,CC,"
>
SYMMBITS 04-10-19 11:14:33
M SV36 COMPLD
  "S1-CLK1:,090-55545-01-B,,D,,D0C1ZZ0AAA,299465"
  "S1-CLK2:,090-55545-01-B,,D,,D0C1ZZ0AAA,299465"
  "S1-OUT1A:,090-55581-01-B,,R4236A,00M16673,D0TPJNMAAA,106045,CC,DS1"
  "S1-OUT2A:,090-55581-01-B,,R4236A,00M16687,D0TPJNMAAA,106045,CC,DS1"
  "S1-OUT3B:,090-55581-01-B,,R4236A,00M16650,D0TPJNMAAA,106045,CC,DS1"
```

The first set of responses (those that begin with "S0-") identify hardware in the Master shelf. The second set of responses (those that begin with "S1-") identify hardware in the Expansion shelf. In this example:

- The S1- indicates that address switch S1 on the Expansion shelf is set to 1. If several shelves are connected, each shelf is identified by Sx, where x is value of S1. Valid values are 1, 2, 3, and 4.
- The S1-CLK1 line identifies the Expansion Controller card in the EC1 slot.
- The S1-CLK2 line identifies the Expansion Controller card in the EC2 slot.
- S1-OUT1A, S1-OUT2A, and S2-OUT3B identify that there are Output Driver cards in slots 1A, 2A, and 3B. Each card has a CC and DS1 Output Connector card installed on the back of the shelf.



Note: If the Management card contains firmware version 4328D, the Expansion Controller cards are identified by ECC1 and ECC2 instead of CLK1 and CLK2. The Clock cards on the Main shelf continue to use CLK1 and CLK2.

3. Enter the command `SW-DX-EQPT` to switch the inactive Clock card to the active state.

Command Example:

The command in this example causes the active Clock card to switch to the secondary Clock card.

```
SW-DX-EQPT::CLK:SC1;
```

A typical response is as follows:

```
<IP SC1
<
  SYMMBITS 04-07-22 15:52:31
M SC1 COMPLD
;

SYMMBITS 04-07-22 15:52:31
A 0095 REPT EVT TSG
"CLK1:CLKACTV,SC,02-22,15-52-31:\\"CLK Active\\""
```

4. Enter the command `RTRV-NETTYPE-ALL` and verify that the expansion shelf's current hardware configuration is listed in the response.



Note: The active clock may take from three to ten minutes to do a complete inventory depending on the number of expansion shelves present.

5. Remove the ECC1 card from the expansion shelf.

6. Verify that an alarm is generated reflecting the removal event.
7. Enter the command `RTRV-NETTYPE-ALL` and verify that the expansion shelf's current hardware configuration is listed in the response.
8. Reinstall the ECC1 card and remove the ECC2 card.
9. Verify that an alarm is generated reflecting the removal event.
10. Enter the command `RTRV-NETTYPE-ALL` and verify that the expansion shelf's current hardware configuration is listed in the response.
11. Reinstall the ECC2 card and verify that no alarms are reported for the expansion shelf. It may take from 15 to 30 seconds for the alarm caused by the removal of the ECC2 card to clear on the IMC.
12. Remove the Expansion Link 1 cable.
13. Verify that an alarm appears for the event.
14. Enter the command `RTRV-NETTYPE-ALL` and verify that the expansion shelf's current hardware configuration is listed in the response.
15. Reinstall the Expansion Link 1 cable and wait for the alarm to clear.
16. Remove the Expansion Link 2 cable.
17. Verify that an alarm appears for the event.
18. Enter the command `RTRV-NETTYPE-ALL` and verify that the expansion shelf's current hardware configuration is listed in the response.
19. Reinstall the Expansion Link 2 cable and wait for the alarm to clear.

Removing Expansion Shelves

To remove an Expansion shelf from a TimeHub system:

1. Disconnect the two Expansion Link cables from the rear of the Expansion shelf. If this was the only Expansion shelf in the system, continue with step 3.
2. Install the Termination Connectors onto the last Expansion shelf in the chain.
3. Issue the following TL1 commands to remove the shelf from the Clock database:

```
ed-eqpt::s1-clk1:sv1::eclkexp=n;  
ed-eqpt::s1-clk2:sv1::eclkexp=n;
```

4. Issue the following TL1 commands to verify that the Expansion shelf is removed from the database :

```
rtrv-eqpt::s1-clk1:sv1::parameter=eclkexp;  
rtrv-eqpt::s1-clk2:sv1::parameter=eclkexp;
```

Chapter 4 Testing and Configuring the TimeHub

This chapter includes:

- Overview
- Installing Cards into the Front Panel
- Installing Cards into the Expansion Shelf
- Establishing a Connection to the TimeHub
- Provisioning Master Shelf Parameters
- Provisioning Inputs on a Master Shelf
- Testing an Expansion Shelf
- Provisioning Inputs on a Remote Shelf
- Testing the Clock Input Signals
- Provisioning the Outputs
- Configuring CC Signals
- Checking System Operation
- Enabling Security
- Setting the Configuration to Factory Defaults

Overview

This chapter describes how to install cards into the front panel and configure the TimeHub 5500. Perform these tasks after you install the shelf and make power, input, alarm, and communications connections described in [Chapter 3, Installing the TimeHub](#). If you encounter any difficulties during the installation process, contact Symmetricom Global Services. See [Contacting Symmetricom Global Services](#), on page 202 for telephone numbers.

Installing Cards into the Front Panel

The procedures in this section describe how to install the cards into the front panel of the TimeHub 5500 shelf. See also [Installing Modules into the Rear Panel](#), on page 77. Refer to [Figure 4-1](#) for the location of the fuse holders and slots for the cards. Turn on power to the shelf as described in [Testing Power Connections](#), on page 76.

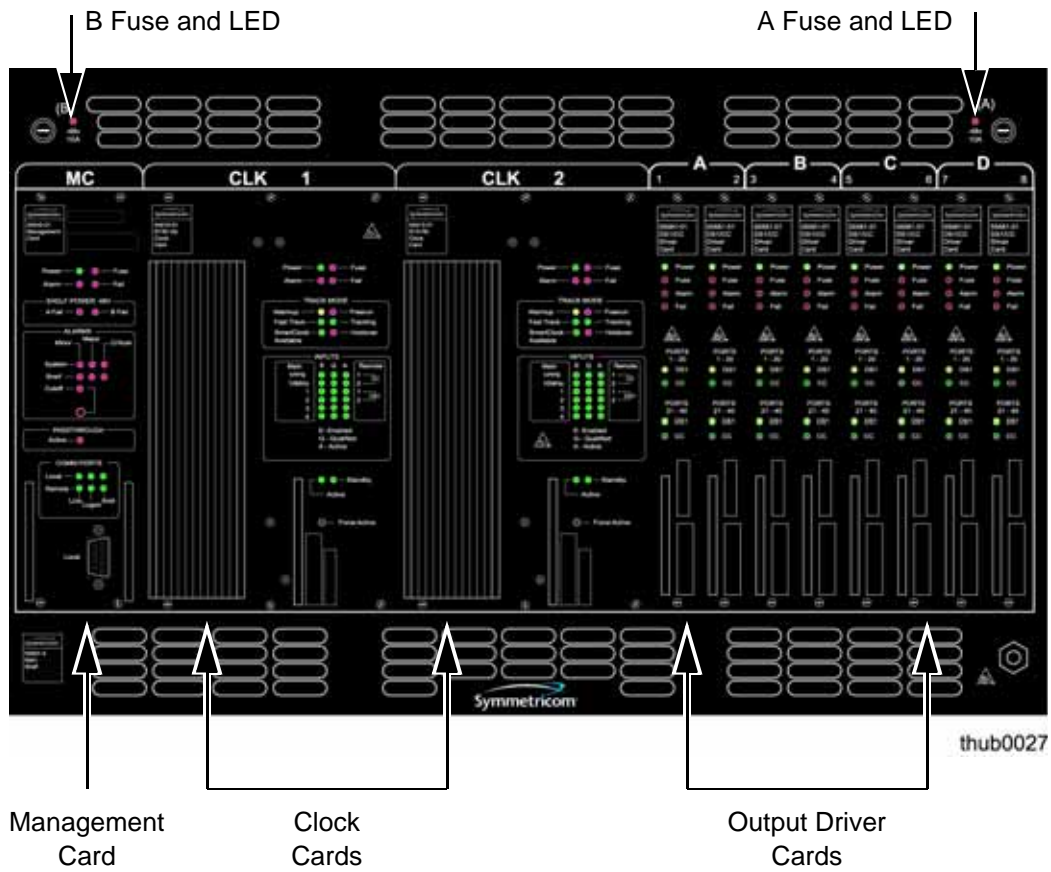

Figure 4-1. Front Panel of the TimeHub 5500 Shelf

Installing the Management Card

To install the Management card, perform the following steps:

1. Visually inspect the Master/Remote switch S1 on the shelf to verify that it is in the correct position. See [Table 3-2](#) for the appropriate setting.
2. Ensure that switch S1 on the Management card is set to the default Off position (see [Figure 4-2](#) and [Table 4-1](#)). This allows you to set up the TimeHub without having to create a user and password.
3. Insert the Management card into the MC slot (the leftmost slot in the shelf). Ensure that the card aligns properly with its mating backplane connector, then push the card into place until it is fully seated into the backplane connectors. Do not tighten the captive screws at this time.

The Power LED turns on and the Alarm LED stays lit until the self-test finishes; the ALARMS Shelf Critical LEDs remains lit since there is no Clock card installed.

4. Verify that the alarm relays are operating correctly using an ohmmeter. The relay pins are on the Input/Alarm Connector module on the rear panel of the shelf.

Measure between the Critical Common pin and the NO pin, and again between the Critical Common pin and the NC pin. The Common-to-NO readings should be shorted and the Common-to-NC readings should be open. Repeat for the Major relay pins.

5. Remove the (A) fuse from the front panel of the shelf by pressing and twisting the holder in a counterclockwise direction with a blade screwdriver. The SHELF POWER –48V A Fail and the ALARMS Shelf Major LEDs light.
6. Replace the –48 volt A fuse. The SHELF POWER –48V A Fail LED turns off, and the ALARMS Shelf Major LED turns off within a few seconds.
7. Remove the (B) fuse by twisting in a counterclockwise direction. The SHELF POWER –48V B Fail and the ALARMS Shelf Major LEDs light.
8. Replace the (B) fuse from the front panel of the shelf. The SHELF POWER –48V B Fail LED turns off, and the ALARMS Shelf Major LED turns off within a few seconds.
9. Press the AUDIBLE ALARM Cutoff pushbutton on the Management card ([Figure 4-3](#)). The ALARMS Cutoff LED lights.
10. Remove both A and B fuses from the shelf. The LEDs next to the fuses light and all LEDs on the Management card turn off.
11. Replace both A and B fuses. The LEDs next to the fuses turn off, the ALARMS Shelf Major, and Minor LEDs light, then turn off. The Critical LED remains on.

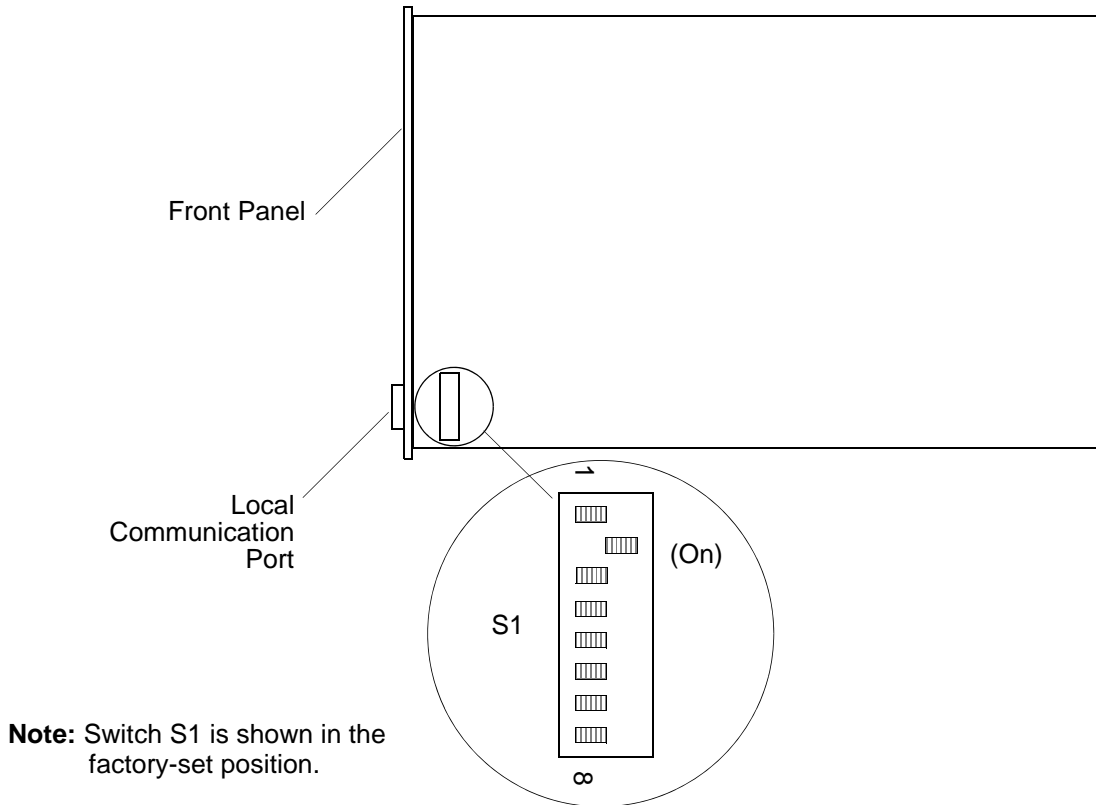
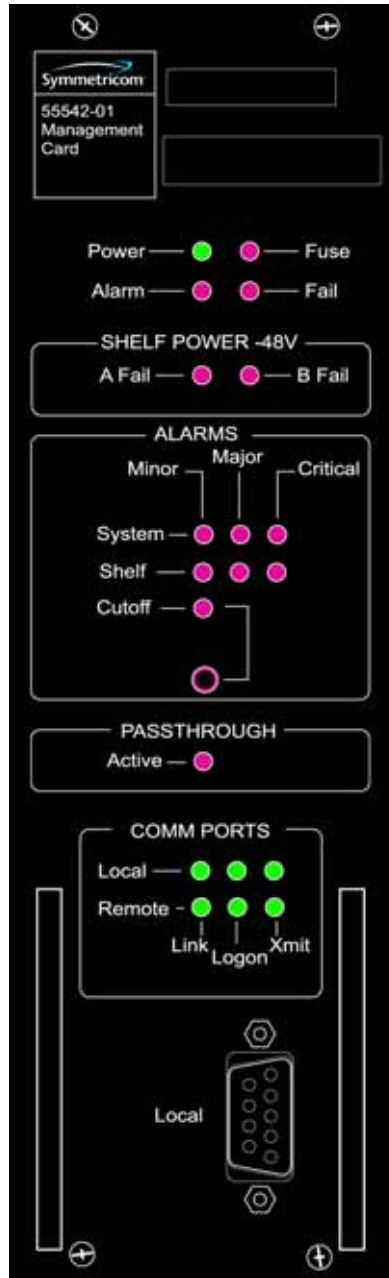

Figure 4-2. Location of Switch S1 on the Management Card

Table 4-1. Management Card S1 Switch Settings

S1 Section	Position	Description	Factory Setting
1	On	Security enable	–
	Off	Security disable. The System Security Disabled alarm (SECUALM) occurs when the switch is in this position.	X
2	On	Force disable local port (local port can be disabled by TL1 command)	X
	Off	Force enable local port (local port is enabled even if previously disabled by TL1 command)	–
3	On	Enforce IP match enable (only communication from the addresses of the primary and/or alternate element managers [EM1 and EM2] will be accepted; communications from all other network addresses will be ignored)	–
	Off	Enforce IP match disable (communication from any network will be accepted)	X
4–8	Off	Reserved for future use	X



thub0008

Figure 4-3. Front Panel of the Management Card

Installing the Clock Cards

To install the Clock cards, perform the following procedure. [Figure 4-4](#) illustrates the front panel of the Clock card.

1. Locate switch S1 on the right side panel of the Clock cards (see [Figure 4-5](#) and [Table 4-2](#)). If both Clock cards are the same (see the label on the front panel), set bit 1 on both Clock cards to the ON position. If you are using mixed Clock cards, set bit 1 on the quartz clock (55511 or 55512) to the OFF position; set bit 1 on the Rb clock (55513 or 55514) to the ON position. If you are using only one clock in the shelf, set bit 1 to ON.
2. Insert either Clock card into the CLK 1 slot (located at the front of the shelf): ensure that the card aligns properly with its mating backplane connector; push the card into place until it is fully seated into the backplane connectors. Do not tighten the captive screws at this time.
3. Insert the second Clock card into the CLK 2 slot: again, ensure that the card is aligned properly and is fully seated. Do not tighten the captive screws at this time.

The Critical Alarm LED on the Management card turns off and the Major Alarm LED turns on after the first clock enters the Freerun state. If you are using only one Clock card, then you must provision the system for single-clock operation (see [Step 5](#), on page 139).

Wait for the Warmup LED to turn off on the Clock card(s) (approximately 2 to 20 minutes per card) and the Tracking LED on at least one of the cards is lit.

At least one of the inputs is qualified when one set of the INPUTS E, Q, and A LEDs is lit on the Clock card. The Clock cards are in Freerun mode when the Warmup LED turns off. To ensure that an input is qualified on a card, refer to the procedure in [Provisioning Inputs on a Master Shelf](#), on page 125.

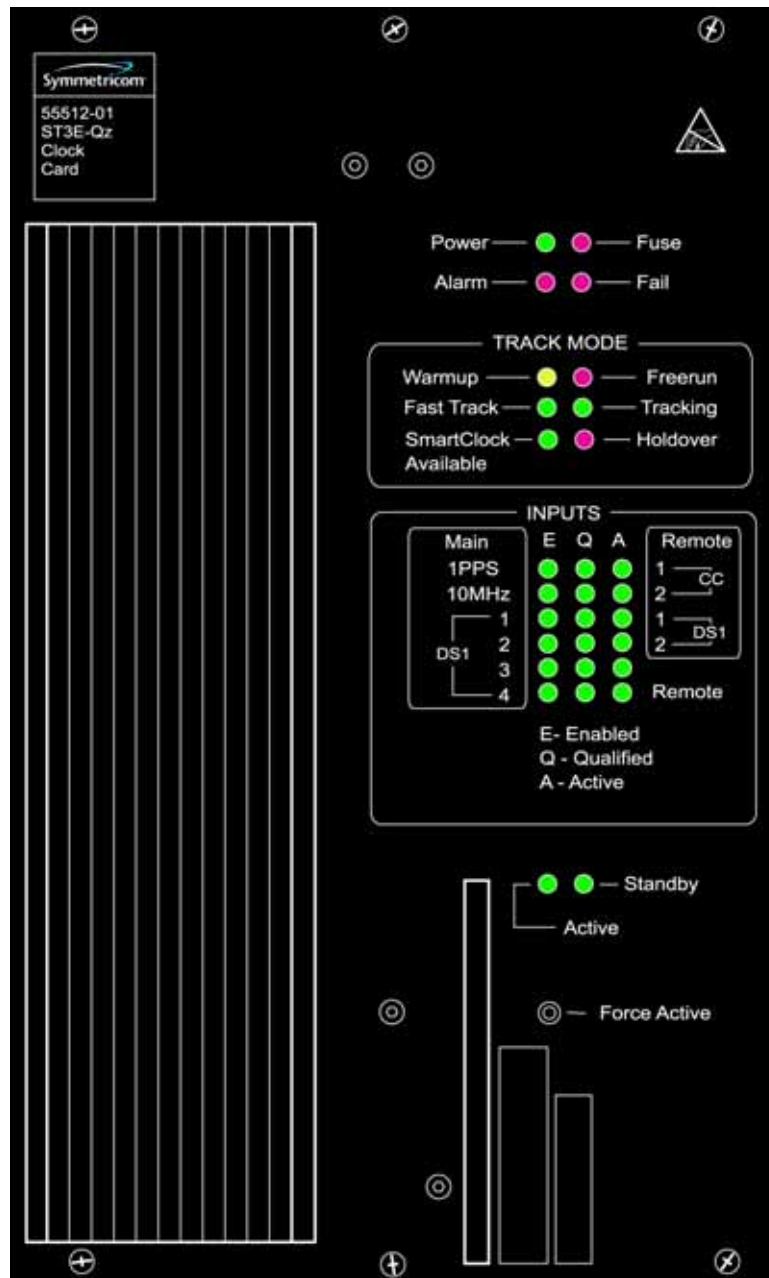

thub0009

Figure 4-4. Front Panel of the Clock Card

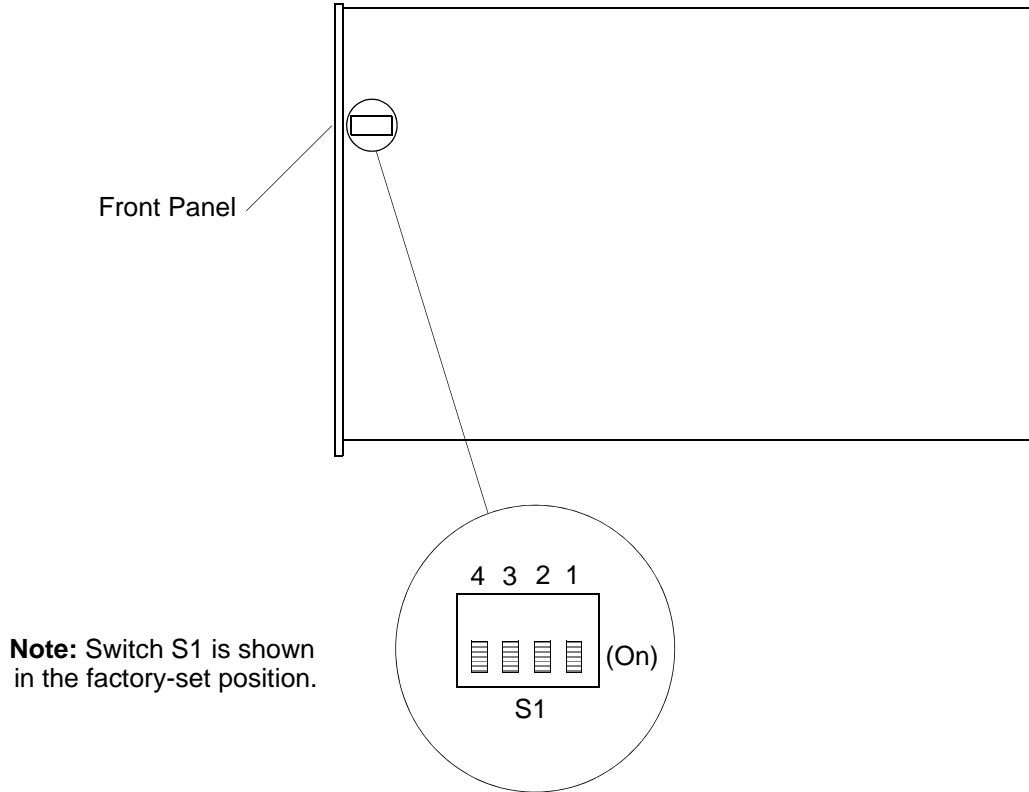

Figure 4-5. Clock Card Switch S1

Table 4-2. Clock Card S1 Switch Settings

S1 Section	Position	Description	Factory Setting
1	On	Normal operation	X
	Off	Mixed oscillator operation. This card contains a secondary oscillator	–
2-4	On	Not used	X

Confirming the Master or Remote Shelf Setting

To confirm that you have properly set the Master/Remote mode, check the Remote LED on the front panel of the Clock card after it enters the Freerun mode (the Freerun LED is lit). The Remote LED lights only if the shelf has been configured for Remote operation. See [Figure 4-4](#) for the location of the “Remote” LED. You can also check the setting by issuing the TL1 command MAINCLK (see the TimeHub 5500 *TL1 Reference Manual* for details).

If the Remote LED responds as expected, the shelf is now properly configured.



Note: The Remote LED can be lit even though the shelf is configured for Master mode. This occurs if the DS1-4 input has been enabled, is qualified, and is being used as the active timing reference. In such a case all three LEDs in the DS1-4 row are illuminated, so it is easy to distinguish this main shelf operating mode from the use of the “Remote” LED as an indicator that the shelf is configured for Remote. When indicating Remote operation, the “E” and “Q” LEDs in the DS1-4 row are never lit.

Installing Output Driver Cards

To install Output Driver cards in a Master shelf, follow the procedure in this section. See [Figure 2-4](#) for the location of the LEDs on the Output Driver card.

For unprotected outputs, install a single Output Driver card into the leftmost of the two slots available for a card group. For protected outputs, install a second Output Driver card into the right slot of the card group.

1. Insert the Output Driver cards (090-55581-01) in the appropriate slots on the front side of the Master or Remote shelf: ensure that the card aligns properly with its mating backplane connector and push the card into place until it is fully seated into the backplane connectors. Do not tighten the captive screws at this time.

The front-panel LEDs blink as the card first powers up. The Power and Alarm LEDs remain lit, as well as LEDs identifying any Output Connector modules installed on the rear panel of the shelf (see [Installing Output Connector Modules](#), on page 78). The Alarm LED indicates that the Master shelf has not yet initialized the card (i.e., received configuration information from the Master shelf).

2. The Master shelf automatically initializes the Output Driver cards according to the current user configuration established for the slot into which the card is inserted.

As each card becomes initialized, its Alarm LED goes out. At this point the card is configured per desired setup and is ready to be further configured if desired. If outputs have been enabled for that card, they should be active.

Note that for a fully loaded shelf, the initialization process could take several minutes in total. If only a single output card is being inserted, the time will be much less than that.

Installing Cards into the Expansion Shelf

If you are configuring an Expansion shelf, continue with this section. If you are configuring a Main shelf only, skip to the next section.

Installing Expansion Controller Cards

When you install Expansion Controller cards into the Expansion shelf, you can also test the links from the Master shelf. The Master shelf and the Expansion shelf must be powered (see [Testing Power Connections](#), on page 76) and at least one Clock card must be installed on the Master shelf (see [Installing the Clock Cards](#), on page 108). The Clock card must be in any mode other than Warmup.

1. Install an EC card (090-55545-01) into the EC1 (leftmost) slot on the front of the Expansion shelf. The Shelf Power A and B LEDs and the Link LEDs light.

The Shelf Power LEDs indicate that power has been properly applied to the shelf, and the Link LEDs indicate that the corresponding link cables are installed properly.

For more detailed checking, disconnect either of the link cables. The corresponding Link LED should turn off. Reconnect the cable and the Link LED lights.

2. Install the second EC card for this Expansion shelf into the EC2 slot, if you are using one. The Power and Link LEDs should be the same as the first EC card. The EC cards are independently connected to and evaluating both links.

The following steps in the link check procedure are optional, because the previous steps have tested that the links are operational. These next steps prove that all LEDs on the EC card(s) are working correctly by confirming that the LEDs remain constant when only CLK1 or only CLK2 is available from the Master shelf. The Clock cards must be in any mode other than Warmup; they do not provide timing while powering up or when in the Warmup state.

3. To check CLK1 only, remove CLK2. Only CLK1 timing is available and should be available over both links. Check that the Link LEDs on both EC cards are lit. The EC card in slot EC2 issues an alarm to indicate that the link from CLK2 is broken. Replace CLK2.
4. Remove CLK1. The Link LEDs should remain green. An alarm is expected on EC1 since the link from CLK1 is broken.

Installing Output Driver Cards

To install Output Driver cards in an Expansion shelf, follow the procedure in this section. See [Figure 2-4](#) for the location of the LEDs on the Output Driver card.

For unprotected outputs, install a single Output Driver card into the leftmost of the two slots available for a card group. For protected outputs, install a second Output Driver card into the right slot of the card group.

1. Insert the Output Driver cards (090-55581-01) in the appropriate slots on the front side of the Expansion shelf: ensure that the card aligns properly with its mating backplane connector and push the card into place until it is fully seated into the backplane connectors. Do not tighten the captive screws at this time.

The front-panel LEDs blink as the card first powers up. The Power and Alarm LEDs remain lit, as well as LEDs identifying any Output Connector modules installed on the rear panel of the shelf. The Alarm LED indicates that the Master shelf has not yet initialized the card (i.e., received configuration information from the Master shelf).

2. The Master shelf automatically initializes the Output Driver cards according to the current user configuration established for the slot into which the card is inserted.

As each card becomes initialized, its Alarm LED goes out. At this point the card is configured per desired setup and is ready to be further configured if desired. If outputs have been enabled for that card, they should be active.

Note that for a fully loaded shelf, the initialization process could take several minutes in total. If only a single output card is being inserted, the time will be much less than that.

Establishing a Connection to the TimeHub

You can connect to the TimeHub 5500 using either a serial connection or an Ethernet connection. To connect via a serial port, see [Communicating by Serial Port](#), on page 114. If the TimeHub is connected to an Ethernet LAN, use the procedure described in [Communicating by Ethernet](#), on page 116. Refer to [Table 4-3](#) for the serial and Ethernet communications port assignments.

Table 4-3. Communications Port Assignments

Port #	Function	Protocol
Serial Ports (RS-232)		
Local (rear panel)	Craft port on rear panel of the shelf	RS-232 ASCII TL1 commands or THC GUI

Table 4-3. Communications Port Assignments (Continued)

Port #	Function	Protocol
Local (Management Card)	Craft port on MC card	RS-232 ASCII TL1 commands or THC GUI
Ethernet Ports		
Use CAT-5 or equivalent cable to connect. Use a straight-through cable to connect to a hub; use a cross-over cable to connect to a computer.		
7588	Command response port	ASCII TL1 commands or THC GUI
7589	Autonomous messages	ASCII TL1 commands or THC GUI
5001 – 20000	User-assigned internal ports	ASCII TL1 commands or THC GUI

Communicating by Serial Port

Two RS-232 ports are available on the TimeHub 5500. Connect a computer with terminal emulation or TimeHub THC software to one of the ports using a null-modem serial cable.

Using TimeScan THC

Use the following procedure to log in to the TimeHub 5500 for the first time using TimeScan THC via a serial connection.

1. Connect one end of the cable to the serial port on the computer or terminal and the other to the Local connector on the rear panel or the Local connector on the Management card.
2. Start the TimeHub THC application. A dialog box asks if you want to connect to Comm Port 1. Click **OK**. The TimeHub TimeScan THC window appears, as shown in [Figure 4-6](#).
3. Click **RS-232** in the Communication tab and set the Comm Port field to match the port connected to the TimeHub.
4. Select the baud rate (default baud rate is 9600), then click the **Connect** check box. The program connects to the TimeHub.
5. Log in as the “admin” user by selecting **Mode of Operation, Advanced Mode**, or by pressing **F5**. The Advanced Mode pop-up window appears.
6. Select the “admin” user from the User Name drop-down box, type `admin` in the Password field, and then click **Login**.
7. Click **OK** in the pop-up box that says “Logged in to Advanced Mode.”

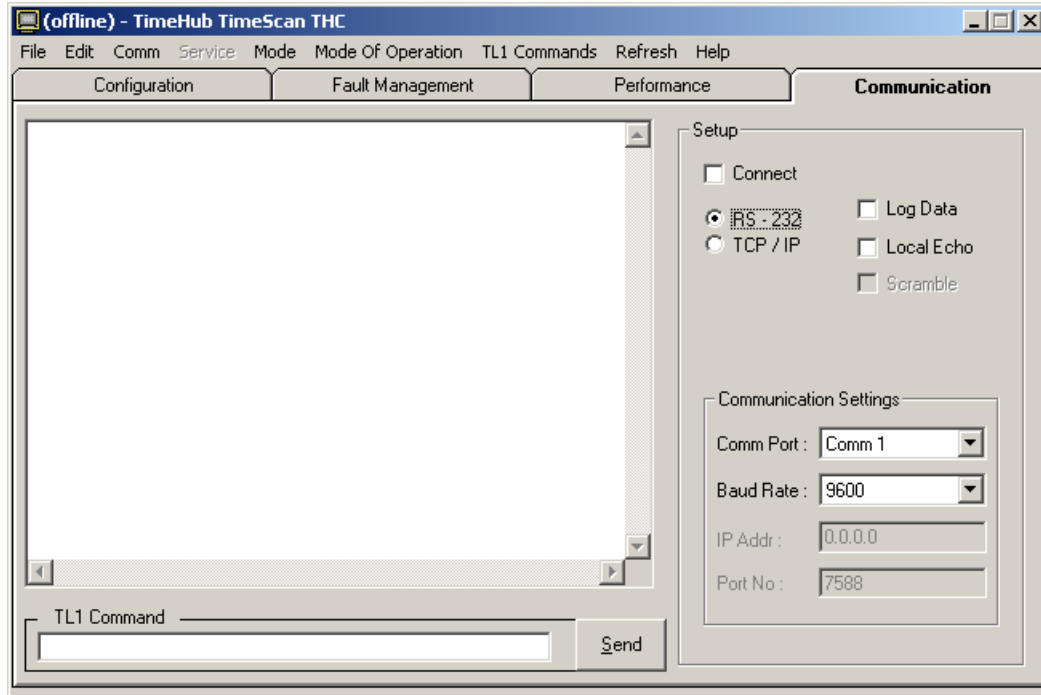

thub0050

Figure 4-6. The TimeHub TimeScan THC Window in Serial Mode

Using Terminal Emulation Software

1. Connect one end of a null-modem cable to the serial port on the computer or terminal and the other to the Local connector on the rear panel or the Local connector on the Management card.
2. Configure the emulation software for 8 data bits, 1 stop bit, no parity, and 9600 baud rate.
3. Start the terminal emulation software and press ; (the TL1 termination character). The system should send a response similar to the following:

```
SYMMBITS 04-10-19 15-25-47
M 0 DENY
  "IICT"
  /* Input, Invalid Correlation Tag (CTAG) */
;
```

If there is no response, check the system installation and setup.

4. If security is enabled on the TimeHub (see [Enabling Security](#), on page 151), issue the ACT-USER command to log in:

```
ACT-USR:[tid]:<aid>:<ctag>::<pid>;
```

where <aid> and <pid> are your user name and password, respectively.

Communicating by Ethernet

To communicate with the TimeHub using an Ethernet LAN, you must first configure the Ethernet port via the serial port. This section describes how to configure the Ethernet port and then connect to the TimeHub using either a Telnet session or TimeScan THC software.

Using TimeScan THC

You establish the network parameters using TimeScan THC connection in the serial mode. To set up a network connection using TimeScan THC:

1. Connect one end of a cable to the serial port on the computer or terminal and the other to the Local connector on the rear panel or the Local connector on the Management card.
2. Start the TimeHub THC application. A dialog box asks if you want to connect to Comm Port 1. Click **OK**. The TimeHub TimeScan THC window appears, as shown in [Figure 4-6](#).
3. Click **RS-232** in the Communication tab and set the Comm Port field to match the port connected to the TimeHub.
4. Select the baud rate (default baud rate is 9600), then click the **Connect** check box. The program connects to the TimeHub.
5. Log in as the “admin” user by selecting **Mode of Operation, Advanced Mode**, or by pressing **F5**. The Advanced Mode pop-up window appears.
6. Select the “admin” user from the User Name drop-down box, type `admin` in the Password field, and then click **Login**.
7. Click **OK** in the pop-up box that says “Logged in to Advanced Mode.”
8. Select **Service, Configure TCP/IP...** from the main menu. The TCP/IP dialog box appears, as shown in [Figure 4-7](#).

See the *TL1 Reference Guide* for details on each of the parameters in this dialog box. Set the parameters appropriately for the network to which the TimeHub is connected. Most important is IPNE, which is the IP address of the TimeHub shelf.

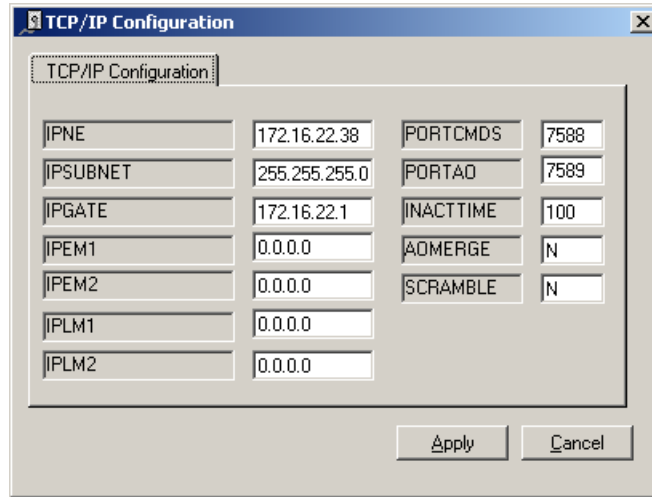

thub0054

Figure 4-7. The TCP/IP Dialog Box

9. Click **Apply** when the parameters are set correctly. A popup appears, requesting you to confirm that you want to make these changes. Click **Yes**. A dialog box similar to that in [Figure 4-8](#) appears.

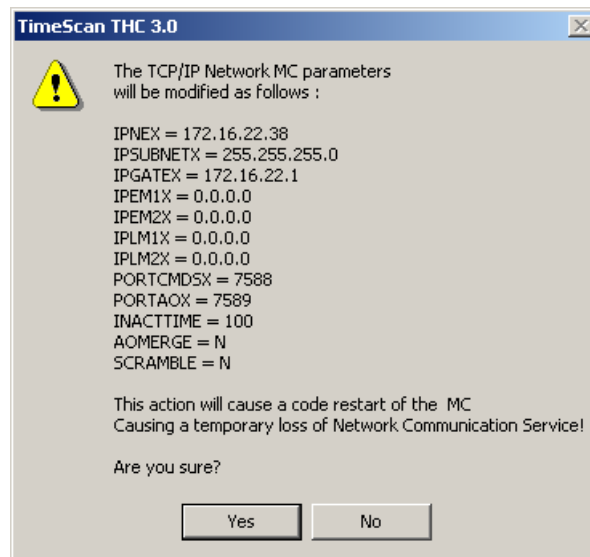

thub0055

Figure 4-8. Network Parameters Dialog Box

10. Verify that the settings are as desired, then click **Yes**. The Management card restarts with the new settings.

Using TL1 Commands

Use the following procedure to configure the Ethernet parameters (IP Address, Subnet Mask, and Gateway Address).

1. Establish a direct serial connection to the TimeHub as described in [Communicating by Serial Port](#), on page 114.
2. Use the Edit Equipment command to specify whether the automatic output messages, and commands and responses will be carried separately on two different ports or combined on one port.

```
ED-EQPT:::<ctag>:::AOMERGE=a;
```

where a = Y (combines automatic output messages, and commands and responses on one port) or N (provides separate ports for automatic output messages, and commands and responses)



Notes:

1. To verify the parameter, issue the Retrieve Equipment command:

```
RTRV-EQPT:::<ctag>:::PARAMETER=AOMERGE;
```
2. If the IP address of the manager matches ILPM1 or IPLM2, the output will be merged, regardless of the AOMERGE value. In this case, the local manager software is used, which does not support having commands and events carried on separate ports. For details on the ILPM1 and IPLM2 parameters, refer to the TimeHub 5500 TL1 Reference Manual.

-
3. Issue the following command to copy the working memory to auxiliary memory.

```
CPY-MEM:::NET:<ctag>:::WKG,AUX;
```

4. Issue the following command to set the TimeHub 5500 IP address.

```
ED-EQPT:::<ctag>:::IPNEX=a.a.a.a;
```

where each a is an independent value between 0 and 255

To verify the parameter, issue the Retrieve Equipment command:

```
RTRV-EQPT:::<ctag>:::PARAMETER=IPNEX;
```

5. Issue the following command to set the subnetwork mask IP address.

```
ED-EQPT:::<ctag>:::IPSUBNETX=a.a.a.a;
```

where each a is an independent value between 0 and 255

To verify the parameter, Issue the following command.

```
RTRV-EQPT:::<ctag>:::PARAMETER=IPSUBNETX;
```

6. Set the Gateway IP address by issuing the following command:

```
ED-EQPT:::<ctag>:::IPGATEX=a.a.a.a;
```

where each a is an independent value between 0 and 2555

To verify the parameter, use the Retrieve Equipment command.

```
RTRV-EQPT:::<ctag>:::PARAMETER=IPGATEX;
```

7. Set the element manager IP address by issuing the following command:

```
ED-EQPT:::<ctag>:::IPEM1X=a.a.a.a;
```

where each a is an independent value between 0 and 255

To verify the parameter, use the Retrieve Equipment command.

```
RTRV-EQPT:::<ctag>:::PARAMETER=IPEM1X;
```

8. Use the Edit Equipment command to set the local manager IP address.

```
ED-EQPT:::<ctag>:::IPLM1X=a.a.a.a;
```

where each a is an independent value between 0 and 255

To verify the parameter, use the Retrieve Equipment command.

```
RTRV-EQPT:::<ctag>:::PARAMETER=IPLM1X;
```

9. Specify the port number for commands and responses by issuing the following command:

```
ED-EQPT:::<ctag>:::PORTCMDSX=a;
```

where a = 5001 to 20000



Notes:

1. To verify the parameter, issue the Retrieve Equipment command.

```
RTRV-EQPT:::<ctag>:::PARAMETER=PORTCMDSX;
```

2. If AOMERGE is set to Y, automatic output messages, and commands and responses are combined on this port.
-

10. If AOMERGE is set to Y, skip to the next step. If AOMERGE is set to N, use the Edit Equipment command to specify the port number for automatic output messages.

```
ED-EQPT:::<ctag>:::PORTAOX=a;
```

where a = 5001 to 20000. The PORTAOX value must be different than the PORTCMDSX value.

To verify the parameter, issue the Retrieve Equipment command:

```
RTRV-EQPT:::<ctag>:::PARAMETER=PORTAOX;
```

11. Use the Copy Network Memory Security command to copy the data from auxiliary to working memory:

```
CPY-MEM-SECU::NET:<ctag>::AUX,WKG;
```

Connecting through Telnet

After you configure the Ethernet port, use the following procedure to connect to it:

1. Ensure that the TimeHub is connected to a LAN. See [Making Communication Connections](#), on page 88 for details.
2. Telnet from your PC to the IP address assigned to the TimeHub. If security is enabled on the TimeHub (see [Enabling Security](#), on page 151), you must log in.
3. To log in, issue the ACT-USER command:

```
ACT-USER:[<tid>]:<aid>:<ctag>::<pid>;
```

where:

<aid> is your user name
<pid> is your password

If you do not have a user name and password, contact the administrator for the TimeHub 5500.

Connecting to TimeScan THC

After you configure the Ethernet port, use the following procedure to connect to it using the TimeScan THC software:

1. Ensure that the TimeHub is connected to a LAN. See [Making Communication Connections](#), on page 88 for details.
2. Start the TimeScan THC application. A dialog box asks if you want to connect to Comm Port 1. Click **Cancel**. The TimeHub TimeScan THC window appears, as shown in [Figure 4-6](#).
3. Click **TCP/IP** in the Communication tab. Enter the IP address and port number in the appropriate boxes.

4. Click the **Connect** check box. The window updates with a list of commands if the connection is established.
5. Log in as the “admin” user by selecting **Mode of Operation, Advanced Mode**, or by pressing **F5**. The Advanced Mode pop-up window appears.
6. Select the “admin” user from the User Name drop-down box, type `admin` in the Password field, and then click Login. Click **OK** in the pop-up box that says “Logged in to Advanced Mode.”

Provisioning Master Shelf Parameters

The TimeScan THC software can help you avoid provisioning errors by providing a graphical user interface that eliminates the need to type TL1 commands. TimeScan THC version 3.0 (or later) allows you to configure the hardware, inputs, outputs, and alarms for a Main shelf and any Expansion shelves connected to it. The configuration procedures that follow this section contain instructions using TimeScan THC as well as the corresponding TL1 commands.

If you are using TimeScan THC version 3.0 (or later), select **Mode, Automatic Messages** to open a window that displays automatic messages from the TimeHub. This form updates whenever the TimeHub sends out an event message. For example, when you install an Expansion Controller card, an event is generated and displayed.

You can also open a window that shows generalized communication to and from the TimeHub by selecting **Mode, Command Response**. Use this window to observe the responses to the following TL1 commands, each of which can be automatically generated from another menu selection:

- **RTRV-NETTYPE-ALL (TL1Commands, RTRV-NETTYPE-ALL or press F2)**: This command retrieves the current hardware configuration of the TimeHub system (Master and Expansion shelves). During configuration, this command shows which components of the system have been identified so far.
- **RTRV-COND (TL1Commands, RTRV-COND or press F3)**: This command retrieves any conditions that are currently active. They may or may not be alarm-generating.
- **RTRV-ALRM (TL1Commands, RTRV-ALRM or press F4)**: This command retrieves only conditions that are active *and* alarm-generating. For example, if only one power terminal is connected on the Expansion shelf, this is reported in the response, and is indicated by LEDs on the front panel of the Expansion Controller card(s).

If you do not have TimeScan THC and use a terminal emulation program instead, all of the above actions can still be performed by typing commands or setting up scripts/special function keys to do so.

Setting the Date and Time

When you first power up the TimeHub, the system starts timekeeping at factory default values. Use the procedures below to set the date and time.

Using TimeScan THC

1. Select **Service, Set TimeHub Date and Time**. The Set TimeHub Date and Time window appears, as shown in [Figure 4-9](#).

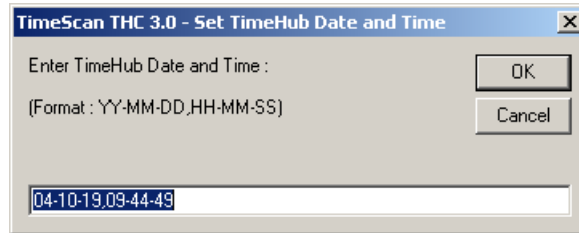

thub0052

Figure 4-9. Set TimeHub Date and Time Window

2. Enter the date and time in the format YY-MM-DD,HH-MM-SS, then click **OK**. The TimeHub responds with the COMPLD message.

Using TL1 Commands

You set the date and time in the TimeHub using the ED-DAT TL1 command. To set the time and date, issue the command:

```
ED-DAT:::SC001::04-10-19,09-44-49;
```

where SC001 is the ctag
04-10-19 is the date (October 19, 2004)
09-44-49 is the time (09:44:49)

The TimeHub responds with the COMPLD message.

Setting the System ID

The System ID <sid> is a name that you assign to identify the TimeHub. All responses from the unit are prefixed with this name. You can use up to 20 characters to identify the unit.



Note: If you include a target identifier <tid> in a command, it is checked against the system identifier <sid> of the TimeHub 5500. The command is executed only if the <tid> and <sid> match; if they do not match, the command is ignored.

Using TimeScan THC

1. Select **Service, Set TimeHub System ID**. The Set TimeHub System ID window appears, as shown in [Figure 4-10](#).

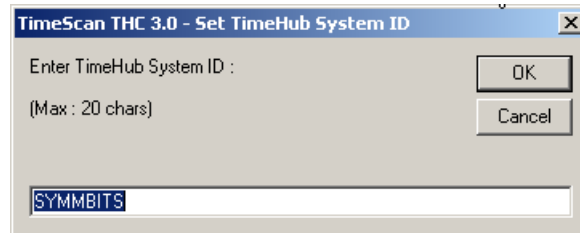

thub0053

Figure 4-10. Set TimeHub System ID Window

2. Type a name for the unit, using up to 20 characters, then click **OK**. The system responds with the COMPLD message.

Using TL1 Commands

To set the system ID, issue the command:

```
SET-SID:::SC002::SYMMBITS;
```

where SC002 is the ctag and SYMMBITS is the system ID

The TimeHub responds with the COMPLD message.

Setting the Target ID

The Target ID <tid> is an optional part of a TL1 command that identifies which device should process the command. You can use up to 20 characters to identify the target.



Note: If you include a target identifier <tid> in a command, it is checked against the system identifier <sid> of the TimeHub 5500. The command is executed only if the <tid> and <sid> match; if they do not match, the command is ignored.

Using TimeScan THC

1. Select **Comm, Change TimeHub Target ID**. The Set TimeHub System ID window appears, as shown in [Figure 4-10](#).

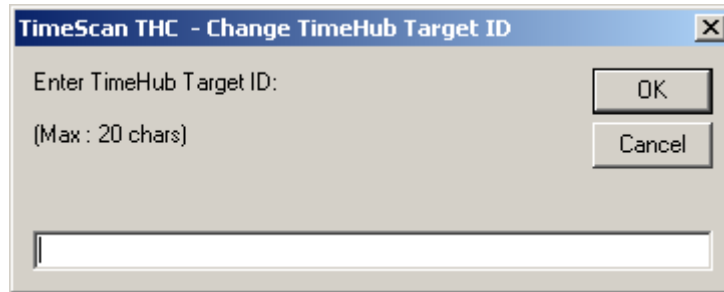

thub0063

Figure 4-11. Set TimeHub Target ID Window

2. Type a name for the unit, using up to 20 characters, then click **OK**. The system responds with the COMPLD message.

Using TL1 Commands

You enter the <tid> in the command line as you type the command. The syntax for each command, shown in the *TL1 Reference Guide*, illustrates the location of the <tid> in the command.

Verifying the Hardware Setup

After you install all the cards, verify that the shelf is configured as expected.

Using TimeScan THC

1. Select **Mode, Command Response** from the main menu to open the Command Response window.
2. Select **TL1Commands, RTRV-NETTYPE-ALL**, or press F2 to send the RTRV-NETTYPE-ALL query. A typical response is as follows:

```
SYMMBITS 04-10-19 11:14:33
M SV36 RTRV
  "TSG:Symmetricom,5500,TSG"
  "S0-IMC: ,090-55542-01-A, ,R4209C,J86746,D0TPN0NAAA,106063"
  "S0-CLK1: ,090-55514-02-A, ,R4142B,J63939,D0TPKRJAAA,297083"
  "S0-CLK2: ,090-55512-02-A, ,R4312A,K60716,D0TPVRKAAA,299460"
  "S0-OUT1A: ,090-55581-01-A, ,R4236A,00M15316,D0TPJNMAAA,105045,CC, "
  "S0-OUT2A: ,090-55581-01-A, ,R4236A,00M15320,D0TPJNMAAA,105045,CC, "
  "S0-OUT3B: ,090-55581-01-A, ,R4236A,00M15317,D0TPJNMAAA,105045,CC, "
  "S0-OUT4B: ,090-55581-01-A, ,R4236A,00M15360,D0TPJNMAAA,105045,CC, "
  "S0-OUT5C: ,090-55581-01-A, ,R4236A,00M15358,D0TPJNMAAA,105045,CC, "
>
SYMMBITS 04-10-19 11:14:33
M SV36 COMPLD
```

```
"S1-CLK1: ,090-55545-01-B, ,D, ,D0C1ZZ0AAA,299465"  
"S1-CLK2: ,090-55545-01-B, ,D, ,D0C1ZZ0AAA,299465"  
"S1-OUT1A: ,090-55581-01-B, ,R4236A,00M16673,D0TPJNMAAA,106045,CC,DS1"  
"S1-OUT2A: ,090-55581-01-B, ,R4236A,00M16687,D0TPJNMAAA,106045,CC,DS1"  
"S1-OUT3B: ,090-55581-01-B, ,R4236A,00M16650,D0TPJNMAAA,106045,CC,DS1"
```

The first set of responses (those that begin with “S0-”) identify hardware in the Master shelf. The second set of responses (those that begin with “S1-”) identify hardware in the Expansion shelf. In this example:

- The S1- indicates that address switch S1 on the Expansion shelf is set to 1. If several shelves are connected, each shelf is identified by Sx, where x is value of S1. Valid values are 1, 2, 3, and 4.
- The S1-CLK1 line identifies the Expansion Controller card in the EC1 slot.
- The S1-CLK2 line identifies the Expansion Controller card in the EC2 slot.
- S1-OUT1A, S1-OUT2A, and S2-OUT3B identify that there are Output Driver cards in slots 1A, 2A, and 3B. Each card has a CC and DS1 Output Connector card installed on the back of the shelf.



Note: If the Management card contains firmware version 4328D, the Expansion Controller cards are identified by ECC1 and ECC2 instead of CLK1 and CLK2. The Clock cards on the Main shelf continue to use CLK1 and CLK2.

Using TL1 Commands

Issue the following TL1 command:

```
RTRV-NETTYPE-ALL;
```

A typical response is shown in the previous section.

Provisioning Inputs on a Master Shelf

After you connect the input signals to the Input/Alarm Connector card (described in [Connecting Timing Inputs](#), on page 86), you need to provision the TimeHub to accept the inputs. The procedures in this section describe how to provision the inputs using the TimeScan THC software and using TL1 commands. You must connect a computer to the TimeHub as described in [Establishing a Connection to the TimeHub](#), on page 113 before you can perform this procedure.

To provision inputs using TL1 commands, see [Using TL1 Commands](#), on page 128.

Using TimeScan THC

Use this procedure to provision the inputs for a Master shelf. If you are provisioning inputs for a Remote shelf, see [Provisioning Inputs on a Remote Shelf](#), on page 136.

Select which inputs will be enabled or disabled. The default is that all inputs are enabled. The enable status of inputs can also be seen on the front panel of each Clock card. Enabling an input means that it can be used as an input timing reference. You disable inputs that are not intended to be used so that unused inputs do not generate alarms (such as **Input Disqualified**). By enabling only those inputs that are expected to be used, such alarms will be more relevant.

1. Select the **Configuration Input** tab. The screen appears as shown in [Figure 4-12](#).

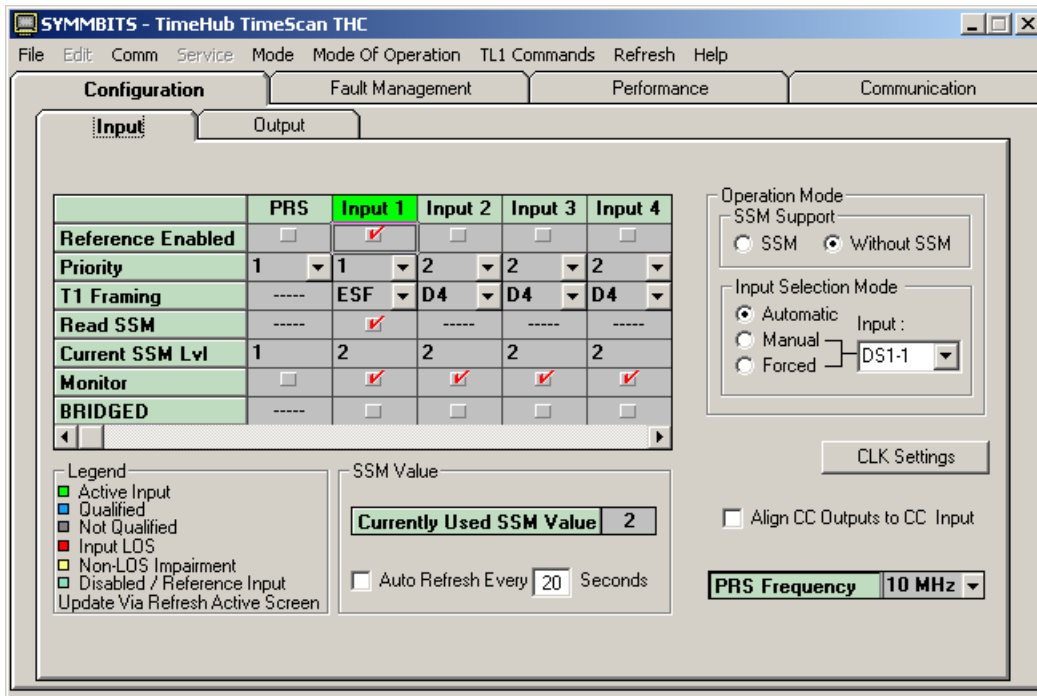

thub0057

Figure 4-12. The TimeScan THC Input Screen

The set of possible inputs appears at the top of the columns. The top row in this table, labeled “Enabled”, shows which inputs are enabled.

2. Place a check in the Enabled row for each input you use, and uncheck inputs that you will not use. The PRS input is the BNC connector on the Input/Alarm Connector card.
3. Select which inputs will not be monitored, if any. The TimeHub can selectively monitor inputs for conditions such as LOS or Loss of Framing even if that input is not enabled. You can monitor the performance of any input without allowing it to be used as a timing reference. By disabling an input but keeping MONITOR enabled, the status of such an input can be observed (via RTRV-COND) and logged without causing an alarm if that input has a problem. Monitoring is enabled by default on inputs 0 – 4.

To change the MONITOR setting, click the Monitor check box for the desired input.

4. Set the PRS Input frequency, if needed. The PRS reference frequency can be set to expect either a 5 or 10 MHz input. The default is 10 MHz. If necessary, change the setting.

Use the control labeled **PRS Frequency** in the lower right of the Configuration Input tab to set the PRS frequency.

5. Change priorities if desired. The priority setting provides a way to prefer a particular input for use as the active timing reference when more than one input has been qualified. The lower the number, the higher the priority. The default is that the PRS input has highest priority and all others are equal. If you want DS1 input 2 to be preferred over DS1 input 1, lower the input 2 priority or raise the input 1 priority.

Use the **Priority** row on the Configuration Input tab to change the priority of the selected input as desired.

6. Set Framing for enabled DS1 inputs, if needed. DS1 inputs may have either D4 (also known as SF) or ESF framing. TimeHub defaults DS1 inputs to expect D4 framing, so if you have ESF inputs the setting needs to be changed.

Use the **T1 Framing** row on the Configuration Input tab to set the framing of selected input as appropriate.

7. Set Bridged mode for enabled DS1 inputs, if needed. Generally, DS1 inputs connected to TimeHub will be terminated at the input. However, if the reference signal is bridged (which means it will be nominally 20 dB lower in amplitude), the bridged selection should be set for any such input. The default setting is that bridged inputs are not expected for inputs 1 – 4.

Use the **BRIDGED** row on the **Configuration, Input** tab to change the setting for any appropriate inputs.

8. Configure inputs to use SSM, if desired. If ESF-framed DS1 inputs contain SSM messages that you want to use as part of the input qualification process, follow steps 9 and 10 to enable the SSM capability. The default is that SSM is not used for qualifying inputs. If you do not want to use SSM for input qualification, continue at [Provisioning the Outputs](#), on page 142.

On the Configuration Input tab, select **SSM** to use SSM as an input qualification criteria. Selecting **Without SSM** causes the TimeHub to ignore SSMs as a consideration for input qualification.

9. Enable SSM reading for ESF-framed DS1 inputs. Inputs that are incapable of SSM decoding (such as PRS or D4-framed DS1) use an assumed SSM value (see keyword QLEVEL in the TimeHub 5500 *TL1 Reference Manual*). The ESF-framed DS1 inputs will also use an assumed value unless reading of SSM is enabled.

On the Configuration Input tab, use the **Read SSM** row to enable actual SSM decoding for ESF-framed DS1 inputs. Note that D4-framed DS1 inputs and the PRS input do not show the **Read SSM** selection since they are not capable of SSM decoding.

To continue provisioning a Master shelf, continue at [Provisioning the Outputs](#), on page 142.

Using TL1 Commands

Use this procedure to provision the inputs for a Master shelf. If you are provisioning inputs for a Remote shelf, see [Provisioning Inputs on a Remote Shelf](#), on page 136.

The DS1 inputs for SSM decoding are connected to the wire-wrap pins labeled “DS1 TERM IN”, rows 1 through 4 on the Input/Alarm Connector module (refer to [Figure 3-7](#) and [Figure 3-17](#)).

The following procedure describes how to set up the DS1 input 1 as an SSM source. The procedure is identical for DS1 inputs 2 through 4 by replacing any references to input 1 with the appropriate input number.

1. Connect the DS1 signal to be used as a source of SSM to the Input/Alarm Connector module pins labeled “DS1 TERM IN” on the row labeled “1” (refer to [Figure 3-7](#) and [Figure 3-17](#)). Typically, this can be any ESF-framed DS1 output from the Main shelf. Such a signal always contains SSM encoding reflecting the current synchronization quality level of the Main shelf.
2. Verify that the “E” LED on the Clock card is lit (if there are two Clock cards in the shelf, observe this LED status on either one). For the DS1 input 1 signal, this is the third row of LEDs in the INPUTS section. Note that this row is labeled DS1-1, indicating that it is providing status on any signal connected to the DS1 input 1 pins on the input module. The “E” LED, when lit, indicates that this input can be used for SSM decoding. If the “E” LED is not lit, that input will not be used for SSM decoding even if the input is present and valid.
3. If the “E” LED is not lit, issue the following command:

```
ED-SYNC::CLK-1:SC1:::ENABLE=Y;
```

The “E” LED should light after you issue this command. To enable DS1 input 2, change `CLK-1` to `CLK-2`.

4. Verify that the input is enabled by issuing the following TL1 command:

```
RTRV-SYNC::CLK-1:SV16:::PARAMETER=ENABLE;
```

5. If the connected DS1 signal is carrying valid SSM, the “Q” LED will light within a few seconds. This LED, when lit, indicates that the input is qualified as providing decodable SSM information.

If the “Q” LED is not lit and the “E” LED is lit, check for:

- No signal. Check the configuration at the source.
- Signal is present but it isn't an ESF-framed DS1. DS1 SF-framed (also known as D4 framing) signals are not capable of SSM encoding. Change the configuration at the source so the framing of this signal is ESF.

If the “Q” LED is lit, a shelf can now use the DS1 input 1 signal as an SSM source. The “A” (Active) LED indicates that this input is currently being used as the source of SSM information for the shelf. When lit, any outputs carrying SSM are encoded with the same SSM value that is being decoded on this input. The “A” LED illuminates when the following condition is present:

- There isn't also a qualified SSM input in the DS1 input 2 row. If there is, it is possible that this input will be selected as the active SSM source instead of the DS1 input 1 signal. When both SSM inputs are valid the one that will be used is determined by the setting of the PRIORITY keyword. The default is that the DS1-1 input has the higher priority, so it will be selected when both inputs are qualified. See TL1 manual for details.

The general TL1 command format for enabling or disabling an input is:

```
ED-SYNC::CLK-a:<ctag>::ENABLE=b;
```

where a = 0 – 4 to identify the input (PRS=0)
b = Y to enable or N to disable the input.

Based on the inputs you will actually use, enable or disable inputs as appropriate. For example, to disable DS1 input 2, issue the command:

```
ED-SYNC::CLK-2:SV343::ENABLE=N;
```

To retrieve the status of an input, issue the command:

```
RTRV-SYNC::CLK-a:SV343::PARAMETER=ENABLE;
```

which shows if the selected input is enabled or disabled.

6. Set PRS Input frequency, if needed. The PRS reference frequency can be set to expect either a 5 or 10 MHz input. The default is 10 MHz. If necessary, change the setting.

To set the PRS Frequency to 5 MHz, issue the following command:

```
ED-SYNC::CLK-0:SV347::PRC5MHZ=Y;
```

Set this value to N when the expected PRS Frequency is 10 MHz.

To retrieve the current setting, type:

```
RTRV-SYNC::CLK-0:SV348::PARAMETER=PRC5MHZ;
```

7. Select which inputs will not be monitored, if any. The TimeHub is capable of selectively monitoring inputs for conditions such as LOS or Loss of Framing even if that input is not enabled. You can performance monitor that input without allowing it to be used as a timing reference. By disabling that input but keeping MONITOR enabled, the status of such an input can be observed (via RTRV-COND) and logged without causing an alarm if that input has a problem. Monitoring is enabled by default on inputs 0 – 4.

To enable or disable monitoring for an input, the TL1 command format is:

```
ED-SYNC::CLK-a:<ctag>::MONITOR=b;
```

where a = 0 – 4 to identify the input (PRS=0)
b = Y to enable monitoring, N to disable monitoring

To prevent retrieval of status information for any disabled inputs, disable the monitoring capability. For example, to disable monitoring of the DS1 input 2, issue the command:

```
ED-SYNC::CLK-2:SV343::MONITOR=N;
```

To determine if monitoring is enabled for a specific input, issue the command:

```
RTRV-SYNC::CLK-a:<ctag>::PARAMETER=MONITOR;
```

8. Change priorities if desired. The priority setting provides a way to prefer a particular input for use as the active timing reference when more than one input has been qualified. The lower the number, the higher the priority. The default is that the PRS input has highest priority and all others are equal. If you want DS1 input 2 to be preferred over DS1 input 1, lower the input 2 priority or raise the input 1 priority.

The general TL1 format for priority setting is:

```
ED-SYNC::CLK-a:SV380::PRIORITY=b;
```

where a = 0 – 4 to identify the input (PRS = 0)
b = 0 – 9 to set the priority value

To set input 2 priority to 3, issue the command:

```
ED-SYNC::CLK-2:SV380::PRIORITY=3;
```

To retrieve the priority setting for input 2, issue the command:

```
RTRV-SYNC::CLK-2:SV381::PARAMETER=PRIORITY;
```

9. Set Framing for enabled DS1 inputs, if needed. DS1 inputs may have either D4 (also known as SF) or ESF framing. TimeHub defaults DS1 inputs to expect D4 framing, so if you have ESF inputs the setting needs to be changed.

The general TL1 format for setting framing is:

```
ED-SYNC::CLK-a:<ctag>::ESF=b;
```

where a = 0 – 4 to identify the input (PRS = 0)
b = Y (ESF framing) or N (D4 framing)

To set input 2 framing to ESF, issue the command:

```
ED-SYNC::CLK-2:SV382::ESF=Y;
```

10. Configure inputs to use SSM, if desired. If you have ESF-framed DS1 inputs providing SSM messages that you want to use as part of the input qualification process, follow steps 10 and 11 to enable the SSM capability. By default, SSM is not used for qualifying inputs. If you do not want to use SSM for input qualification, skip to step 12.

Select SSM to be used as an input qualification criteria by issuing the command:

```
ED-EQPT::CLK:SV41::SYNCMDE=SSM;
```

11. Set Bridged mode for enabled DS1 inputs, if needed. Generally, DS1 inputs connected to TimeHub will be terminated at the input. However, if the reference signal is bridged (which means it will be nominally 20 dB lower in amplitude), the bridged selection should be set for any such input. The default setting is that bridged inputs are not expected for inputs 1 – 4.

The general TL1 format for bridged setting is:

```
ED-SYNC::CLK-a:<ctag>::BRIDGED=b;
```

where a = 1 – 4 to identify the input whose bridged state is being set
b = Y for Bridged expected, N for Bridged not expected (i.e., terminated)

To set input 1 to expect a bridged signal level, issue the command:

```
ED-SYNC::CLK-1:SV385::BRIDGED=Y;
```

To retrieve the bridged setting for input 1, issue the command:

```
RTRV-SYNC::CLK-1:SV386::PARAMETER=BRIDGED;
```

To disallow the use of SSMs as input qualification criteria, issue the command:

```
ED-EQPT::CLK:SV43::SYNCMDE=AUTO;
```

To retrieve the current selection, issue the command:

```
RTRV-EQPT::CLK:SV42::PARAMETER=SYNCMDE;
```

12. Enable SSM reading for ESF-framed DS1 inputs. Inputs that are incapable of SSM decoding (such as PRS or D4-framed DS1) use an assumed SSM value (see keyword QLEVEL in the *TL1 Reference Manual*). The ESF-framed DS1 inputs will also use an assumed value unless reading of SSM is enabled.

To enable SSM decoding for a given ESF-framed DS1 reference, issue the command:

```
ED-SYNC::CLK-a:<ctag>::SSMENB=b;
```

where a = 1 – 4 and is the input reference that should decode SSM.
a = N disables decoding

For example, to enable SSM decoding on input 1 (first DS1 input), issue the command:

```
ED-SYNC::CLK-1:SV48::SSMENB=Y;
```

To retrieve the current setting of SSM decoding for input 1, issue the command:

```
RTRV-EQPT::CLK-1:SV49::PARAMETER=SSMENB;
```

To continue provisioning a Master shelf, continue at [Provisioning the Outputs](#), on page 142.

Testing an Expansion Shelf

This test procedure provides the steps needed to ensure that a TimeHub 5500 expansion shelf is correctly installed and functioning properly. Before performing this test, ensure that the TimeHub 5500 Master shelf and Expansion shelf are rack mounted and that all cable connections are complete.

- For installation instructions, see [Rack Mounting the TimeHub 5500](#), on page 67, and [Installing Expansion Shelves](#), on page 92.
- For communications connection instructions, see [Establishing a Connection to the TimeHub](#), on page 113.
- For provisioning instructions, see [Provisioning Master Shelf Parameters](#), on page 121.



Note: The power bus wiring must be verified for correct polarity prior to applying power. Failure to observe the correct polarity will result in damage to the expansion shelf backplane. The damage will not be apparent under normal operation but disconnection of the return on one of the power busses may result in loss of power to the shelf.

Perform the following procedure to verify the operation of the expansion shelf:

1. Establish either a serial or Ethernet communications connection to the TimeHub 5500.
2. Enter the command `RTRV-NETTYPE-ALL` (as shown in the following example) and verify that the expansion shelf's current hardware configuration is listed in the response.



Note: The active clock may take from three to ten minutes to do a complete inventory depending on the number of expansion shelves present.

Command Example:

Issue the following TL1 command:

```
RTRV-NETTYPE-ALL;
```

Or, using TimeScan THC:

1. Select **Mode, Command Response** from the main menu to open the Command Response window.
2. Select **TL1Commands, RTRV-NETTYPE-ALL**, or press F2 to send the `RTRV-NETTYPE-ALL` query.

A typical response is as follows:

```
SYMMBITS 04-10-19 11:14:33
M SV36 RTRV
  "TSG:Symmetricom,5500,TSG"
  "S0-IMC:,090-55542-01-A,,R4209C,J86746,D0TPN0NAAA,106063"
  "S0-CLK1:,090-55514-02-A,,R4142B,J63939,D0TPKRJAAA,297083"
  "S0-CLK2:,090-55512-02-A,,R4312A,K60716,D0TPVRKAAA,299460"
  "S0-OUT1A:,090-55581-01-A,,R4236A,00M15316,D0TPJNMAAA,105045,CC,"
  "S0-OUT2A:,090-55581-01-A,,R4236A,00M15320,D0TPJNMAAA,105045,CC,"
  "S0-OUT3B:,090-55581-01-A,,R4236A,00M15317,D0TPJNMAAA,105045,CC,"
  "S0-OUT4B:,090-55581-01-A,,R4236A,00M15360,D0TPJNMAAA,105045,CC,"
  "S0-OUT5C:,090-55581-01-A,,R4236A,00M15358,D0TPJNMAAA,105045,CC,"
>
SYMMBITS 04-10-19 11:14:33
M SV36 COMPLD
```

```
"S1-CLK1: ,090-55545-01-B,,D,,D0C1ZZ0AAA,299465"  
"S1-CLK2: ,090-55545-01-B,,D,,D0C1ZZ0AAA,299465"  
"S1-OUT1A: ,090-55581-01-B,,R4236A,00M16673,D0TPJNMAAA,106045,CC,DS1"  
"S1-OUT2A: ,090-55581-01-B,,R4236A,00M16687,D0TPJNMAAA,106045,CC,DS1"  
"S1-OUT3B: ,090-55581-01-B,,R4236A,00M16650,D0TPJNMAAA,106045,CC,DS1"
```

The first set of responses (those that begin with "S0-") identify hardware in the Master shelf. The second set of responses (those that begin with "S1-") identify hardware in the Expansion shelf. In this example:

- The S1- indicates that address switch S1 on the Expansion shelf is set to 1. If several shelves are connected, each shelf is identified by Sx, where x is value of S1. Valid values are 1, 2, 3, and 4.
- The S1-CLK1 line identifies the Expansion Controller card in the EC1 slot.
- The S1-CLK2 line identifies the Expansion Controller card in the EC2 slot.
- S1-OUT1A, S1-OUT2A, and S2-OUT3B identify that there are Output Driver cards in slots 1A, 2A, and 3B. Each card has a CC and DS1 Output Connector card installed on the back of the shelf.



Note: If the Management card contains firmware version 4328D, the Expansion Controller cards are identified by ECC1 and ECC2 instead of CLK1 and CLK2. The Clock cards on the Main shelf continue to use CLK1 and CLK2.

3. Enter the command `SW-DX-EQPT` to switch the inactive Clock card to the active state.

Command Example:

```
SW-DX-EQPT::CLK:SC1;
```

The command in this example causes the active Clock card to switch to the secondary Clock card.

A typical response is as follows:

```
<IP SC1  
<  
SYMMBITS 04-07-22 15:52:31  
M SC1 COMPLD  
;  
  
SYMMBITS 04-07-22 15:52:31  
A 0095 REPT EVT TSG  
"CLK1:CLKACTV,SC,02-22,15-52-31:\\"CLK Active\\""
```

4. Enter the command `RTRV-NETTYPE-ALL` and verify that the expansion shelf's current hardware configuration is listed in the response.



Note: The active clock may take from three to ten minutes to do a complete inventory depending on the number of expansion shelves present.

5. Remove the ECC1 card from the expansion shelf.
6. Verify that an alarm is generated reflecting the removal event.
7. Enter the command `RTRV-NETTYPE-ALL` and verify that the expansion shelf's current hardware configuration is listed in the response.
8. Reinstall the ECC1 card and remove the ECC2 card.
9. Verify that an alarm is generated reflecting the removal event.
10. Enter the command `RTRV-NETTYPE-ALL` and verify that the expansion shelf's current hardware configuration is listed in the response.
11. Reinstall the ECC2 card and verify that no alarms are reported for the expansion shelf. It may take from 15 to 30 seconds for the alarm caused by the removal of the ECC2 card to clear on the IMC.
12. Remove the Expansion Link 1 cable.
13. Verify that an alarm appears for the event.
14. Enter the command `RTRV-NETTYPE-ALL` and verify that the expansion shelf's current hardware configuration is listed in the response.
15. Reinstall the Expansion Link 1 cable and wait for the alarm to clear.
16. Remove the Expansion Link 2 cable.
17. Verify that an alarm appears for the event.
18. Enter the command `RTRV-NETTYPE-ALL` and verify that the expansion shelf's current hardware configuration is listed in the response.
19. Reinstall the Expansion Link 2 cable and wait for the alarm to clear.

Provisioning Inputs on a Remote Shelf

Remote shelves use either or both of the two Composite Clock inputs on the Input/Alarm Connector module. These timing signals are typically provided from a TimeHub or DCD Master shelf. You need to provision which of the CC inputs are enabled. The default is that both inputs are enabled. LEDs on the front panel of the Clock card(s) in the Remote shelf indicate the enable status of the inputs. When you enable an input it can be used as an input timing reference. You should disable unused inputs so that they do not generate alarms (such as **Input Disqualified**).

The following procedure describes how to set up the CC1 input as a timing reference. This procedure is identical for CC2 by replacing any references to CC1 with CC2.

To provision the Remote inputs using TL1 commands, see [Using TL1 Commands](#), on page 138.

Using TimeScan THC

1. Select the **Configuration, Input** tab. The **Input Configuration** screen appears, as shown in [Figure 4-14](#).

The columns labeled **CC1** and **CC2** identify the inputs that can be selected as timing references. The other columns (**SSM 1** and **SSM 2**) are advanced features that are not covered here. The top row in this screen, labeled **Enabled**, shows which inputs are enabled.

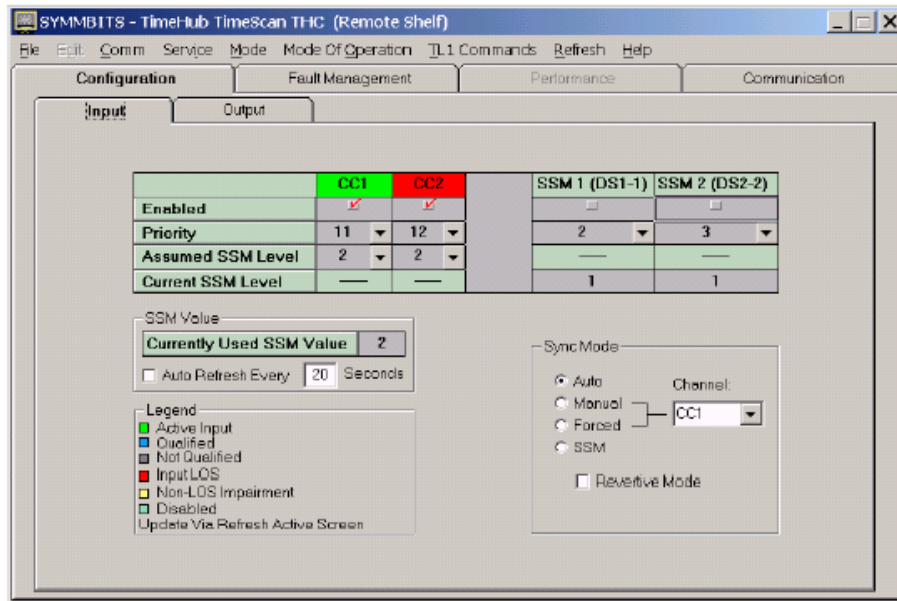

Figure 4-13. The Remote Input Configuration Window

- Based on the timing references planned for this installation, set the Enabled row appropriately. Click the Enabled box (a check mark is present) for CC inputs that you will use, uncheck CC inputs that you will not use.
- Verify that the input is enabled by checking the “E” LED on the front panel of either Clock card (see Figure 4-4). Note that the Clock panel labeling is to the right of the LEDs in the INPUTS section. The first row of three LEDs is labeled CC1. In this step, verify that the “E” LED in that row is lit. Note that when the “E” LED is lit, the input has been selected as a possible timing reference; it does not indicate that a valid input is connected.

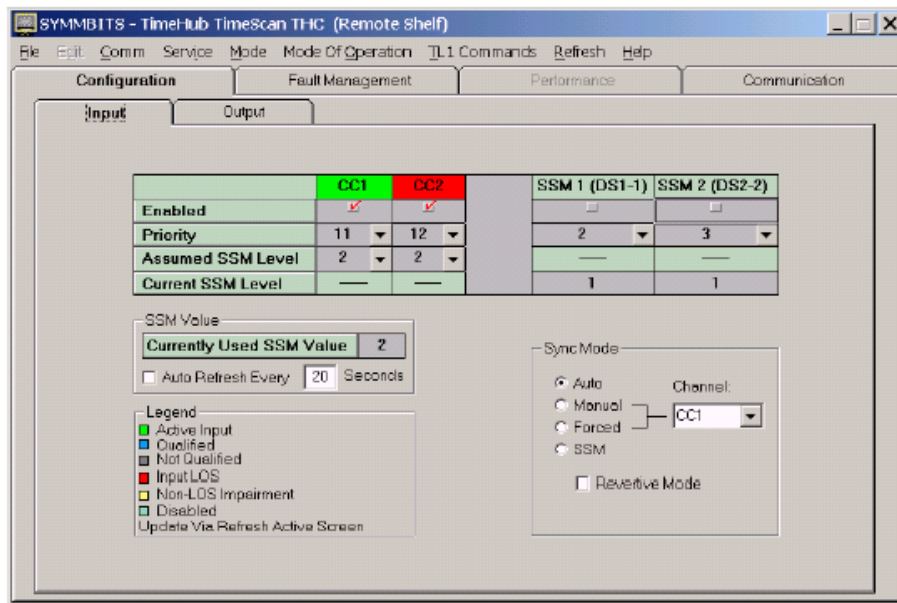

Figure 4-14. The Remote Input Configuration Window

- Verify that the input is qualified by checking that the “Q” LED (in the same row as the “E” LED) is lit. It can take up to several minutes for the “Q” LED to light after the “E” has been lit. When this LED lights, the input meets all requirements for use as a timing source (signal presence, framing, within frequency pull-in range all confirmed).

If the “Q” LED does not light, there is most likely a problem with the input. Typical causes are no signal present or improper connection to the Input/Alarm Connector module.



Note: You can observe progress toward qualification via either the local or LAN communications port. The TL1 RTRV-COND command provides this information (for example, input loss of signal or out of frame can be observed via RTRV-COND). Refer to the TimeHub 5500 *TL1 Reference Manual* for details.

5. Set the priority of either CC1 or CC2 as desired. The priority setting provides a way to select one of the CC inputs when both inputs are qualified. The lower the number, the higher the priority. The default is that the CC1 has higher priority than CC2; CC1 is always used when it is qualified.

Assuming that CC1 is the only qualified input, the “A” LED should also light, indicating that this is the Active timing reference, the one being used to drive outputs provided by this shelf.

The TimeHub Remote shelf can produce outputs in Freerun mode (in other words, without a qualified input) by using the FREEACT TL1 keyword. The default setting for FREEACT on a remote shelf is SQUELCH, which means no output is possible when in Freerun mode. By setting it to CONTINUE output is allowed in when in Freerun. See the TimeHub 5500 *TL1 Reference Manual* for details.

Using TL1 Commands

If you are using terminal software, the general TL1 command format for enabling or disabling an input is:

```
ED-SYNC::CLK-a:<ctag>:::ENABLE=b;
```

where a = 10 or 11 (10 = CC1, 11 = CC2)
b = Y to enable, N to disable the input

1. Enable or disable inputs as appropriate for your installation. For example, to enable CC1, type:

```
ED-SYNC::CLK-10:SV460:::ENABLE=Y;
```

To enable CC2, substitute CLK-11 for CLK-10.

Issue the following TL1 command to verify that the input is enabled:

```
RTRV-SYNC::CLK-11:SV461:::PARAMETER=ENABLE;
```

2. Verify that the input is enabled by checking the “E” LED on the front panel of either Clock card (see [Figure 4-4](#)). Note that the Clock panel labeling is to the right of the LEDs in the INPUTS section. The first row of three LEDs is labeled CC1. In this step, verify that the “E” LED in that row is lit. Note that when the “E” LED is lit, the input has been selected as a possible timing reference; it does not indicate that a valid input is connected.
3. Verify that the input is qualified by checking that the “Q” LED (in the same row as the “E” LED) is lit. It can take up to several minutes for the “Q” LED to light after the “E” has lit. When this LED lights, the input meets all requirements for use as a timing source (signal presence, framing, within frequency pull-in range all confirmed).

If the “Q” LED does not light, there is most likely a problem with the input. Typical causes are no signal present or improper connection to the Input/Alarm Connector module.



Note: You can observe progress toward qualification via either the local or LAN communications port. The TL1 RTRV-COND command provides this information (for example, input loss of signal or out of frame can be observed via RTRV-COND). Refer to the TimeHub 5500 *TL1 Reference Manual* for details.

Assuming that CC1 is the only qualified input, the “A” LED should also light, indicating that this is the Active timing reference, the one being used to drive any outputs provided by this shelf.

Once either the CC1 or CC2 input has been qualified, the Remote shelf can generate outputs. The TimeHub Remote shelf can produce outputs in Freerun mode (in other words, without a qualified input) by using the FREEACT TL1 keyword. The default setting for FREEACT on a Remote shelf is SQUELCH, which means no output is possible when in Freerun mode. By setting FREEACT to CONTINUE, output is allowed in when in Freerun. See the TimeHub 5500 *TL1 Reference Manual* for details.

4. Set the priority of either CC1 or CC2 as desired. The priority setting provides a way to select one of the CC inputs when both inputs are qualified. The lower the number, the higher the priority. The default is that the CC1 has higher priority than CC2; CC1 is always used when it is qualified.

The general TL1 command format to set priority is:

```
ED-SYNC::CLK-a:SV380:::PRIORITY=b;
```

where a = 10 or 11 (10 = CC1, 11 = CC2)
b = 0 – 12 (the actual priority value)

To set CC2 priority to 3, issue the command:

```
ED-SYNC::CLK-11:SV380:::PRIORITY=3;
```

To retrieve the Priority setting for CC2, type:

```
RTRV-SYNC::CLK-11:SV381:::PARAMETER=PRIORITY;
```

5. If you are using only one Clock card, use the SINGLCK keyword to disable the alarm that is usually associated with this mode of operation. Issue the TL1 command:

```
ED-EQPT::IMC:SC01:::SNGCL=Y;
```

See the *TL1 Reference Manual* for more information about the SINGLCK keyword.

Testing the Clock Input Signals

Prior to testing the clock input signals, ensure that the following has been performed:

- Each available DS1 reference is connected to the appropriate DS1 input wire-wrap pins on the Input/Alarm Connector module:
 - Terminated DS1s are connected to any of the four pins labeled “DS1 TERM IN”
 - Bridged DS1s are connected to any of the four pins labeled “DS1 BRDG IN”
- The 5 MHz or 10 MHz PRS input reference is connected to the BNC connector labeled “5/10 MHz IN”
- The CC input(s) for a Remote shelf are connected to the appropriate CC In wire-wrap pins on the Input/Alarm Connector module

Input signal level requirements for the PRS inputs, DS1 terminated inputs, and DS1 bridged inputs are covered in [Chapter 6, Specifications](#).

To verify that the clock input signal(s) are within the specified input voltage range, perform the following procedure using a dual-channel oscilloscope with a 100 MHz minimum bandwidth.

1. Set the oscilloscope controls as listed in [Table 4-4](#). Consult the oscilloscope manufacturer’s manual for details and operating instructions.
2. Connect the X10 probes to the channel 1 and channel 2 oscilloscope inputs, and install a terminating resistor across the probes.
3. Connect the channel 1 and 2 probe ground leads together.
4. Connect the channel 1 and 2 probes (with resistor) to T and R of each DS1 reference input on the Input/Alarm Connector module (refer to [Figure 2-5](#)).
5. Verify that the clock input signal(s) are within the specified input voltage range and meet the prescribed template. Consult your local specifications for the type of input signals installed and on which input connectors.

Input signal ranges are as follows:

- DS1 Terminated: 1.0 V to 3.5 V base-to-peak, 100 Ω terminated
- DS1 Bridged: 0.10 V to 0.35 V base-to-peak, 100 Ω terminated
- CC: 1.5 V to 4.0 V base-to-peak, 130 Ω terminated (only used with Remote shelf)

Table 4-4. Typical Oscilloscope Settings

Control	Setting
Mode Trigger Switch	ADD
Invert Switch	INVERT
Ch1 and Ch2: Volts/Div Input Coupling Vert Position Control	See Note AC mid-range
A Sweep Mode	AUTO-TRIGGER
Horizontal Display Switch	A
Time/Div Switch: for CC for DS1	20 μ s 500 ns
A Sweep	FULL
Horizontal Position Control	mid-range
A Triggering: Slope Coupling Source	+ or – AC INT

Note: Adjust the oscilloscope's volts-per-division scale to the appropriate level to get a measurable pulse amplitude on the screen; for example, to measure a 0 dB DSX (TERM) signal, set the volts-per-division scale to 1 V per division; to measure a –20 dB DSX (BRDG) signal, set the volts-per-division scale to 100 mV per division.

Provisioning the Outputs

This section describes how to provision the outputs in a TimeHub Master/Remote or Expansion shelf. There are three steps to provisioning an output:

- Placing in service the output card group that supplies the output
- Selecting the framing for the output, if appropriate
- Enabling the specific output port so that a signal will be produced on that port
- Setting the output protection as desired
- Setting the cable compensation for CC inputs, if applicable

For a given port to generate outputs, you must enable the port AND you must place in-service the card group that contains that port (A, B, C, or D for the Master shelf).

To provision outputs using TL1 commands, see [Using TL1 Commands](#), on page 144.

Using TimeScan THC

You can provision outputs using the **Configuration Output** tab in the TimeScan THC application, as shown in [Figure 4-15](#).

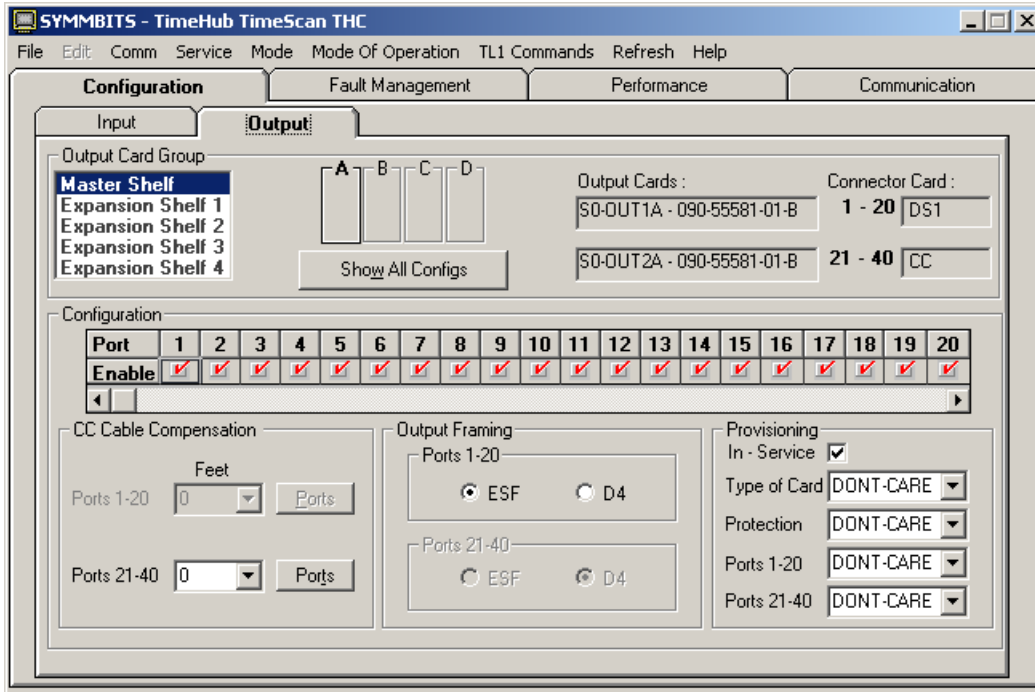

thub0056

Figure 4-15. Configuring Outputs Using TimeScan THC

1. Select the output card group you want to provision by selecting the shelf and the output group. The upper right portion of the form shows information on the Output Connector cards installed in the selected card group. [Figure 4-15](#) shows that two Output Connector cards are installed on the A group of the Master shelf: a DS1 card on ports 1-20 and a CC card on ports 21-40.
2. Place the cards in service by clicking the “In-Service” check-box in the Provisioning section. As shown in the form above, the A output group is currently in-service.
3. Use the drop-down boxes in the Provisioning section to select the type of card you are provisioning, whether protection is required (a backup card must be installed), and the output type for ports 1-20 and 21-40.

Card type – An event is generated if you install an Output Connector card that is not the same as the value entered in this field, which matches the card installed in the shelf. If “Don’t Care” is selected, no event is generated.

Protection – Set to Required if two Output Driver cards must be installed for an output group (A through D or A through H). An event is generated if one of an Output Driver card pair is removed or not installed.

Ports 1–20 – Set to Required to generate an event if you install an Output Connector card of the wrong type.

4. To set the framing, select the appropriate choice in the “Output Framing” portion of this form (lower center of form). In this case, ports 1-20 are shown to be set to D4 framing. Note that framing for ports 21-40 is disabled because those ports have a CC Output Connector card (which has no framing choice).
5. Enable any specific port of interest by checking the associated check box for the desired port. The control for this is in the center of the form, covering the entire width. What can be viewed in the above form shows that ports 7 through 26 are all turned on. The scroll bar allows the other ports to be seen. Right-click in this portion of the window to enable or disable all inputs at once.

Requirements:

- DS1 output waveforms must be as shown in [Figure 4-16](#).
- CC output waveforms must be as shown in [Figure 4-17](#).

For DS1 output waveforms, only the positive pulse is shown. The negative pulse is an upside-down, mirror image of the positive pulse.

6. Set the cable compensation for Composite Clock outputs using the procedure in [Configuring CC Signals](#), on page 146.

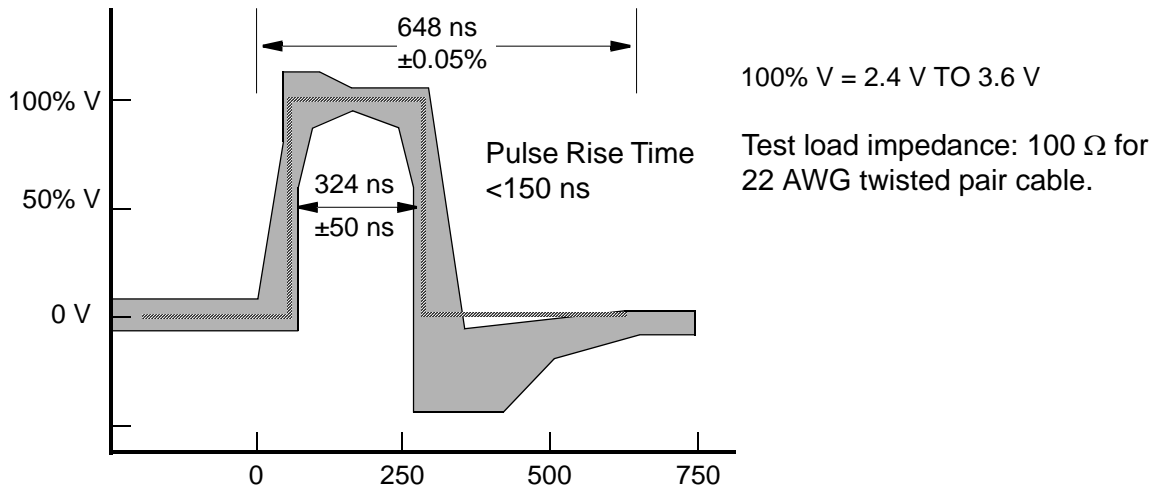

Figure 4-16. DS1 Output Waveforms

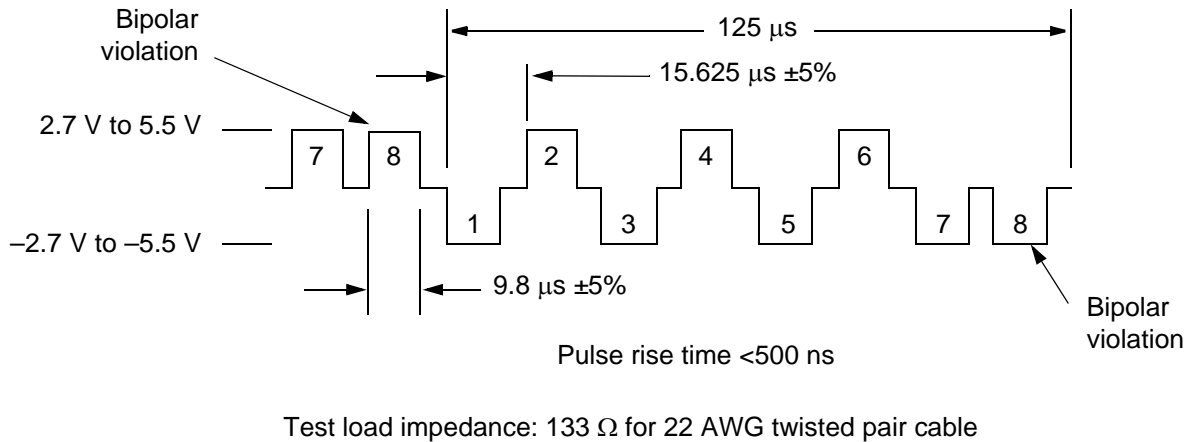

Figure 4-17. CC Output Waveforms

Using TL1 Commands

To enable an output port of interest, you must put the card in-service, set the output framing (if appropriate), and enable the specific port.

1. Place the card in-service by issuing the following TL1 command:

```
ED-EQPT::S1-OUTC:SV267:::INSRVC=Y;
```

In the above example, the card being put in service is located in Expansion shelf 1 (S1-), the card is in the C group (OUTC), and SV267 is the ctg.

A successful response is:

```
SYMMBITS 04-10-11 10:35:54
M SV267 COMPLD
;
```

2. Check the INSRVC setting by issuing the following TL1 command:

```
RTRV-EQPT::S1-OUTC:SV268:::PARAMETER=INSRVC;
```

which produces the following response, showing that this card is in-service (INSRVC = N indicates that it is not in-service):

```
SYMMBITS 04-10-11 10:35:54
M SV268 COMPLD
"S1-OUTC::INSRVC = Y"
;
```

3. If this port is connected to a DS1 Output Connector card, you may need to provision the output framing. Issue the following TL1 command:

```
ED-EQPT::S1-OUTC-PG2:SV271:::OUTESF=Y;
```

where S1- indicates Expansion shelf 1
OUTC indicates output group C
PG2 indicates Program Group 2 (channels 21 – 40)
SV271 is the ctag
OUTESF = Y indicates ESF (N indicates D4/SF)

The response to the above command is:

```
SYMMBITS 04-10-11 10:43:40
M SV271 COMPLD
;
```

4. Check the framing setting by issuing the following command:

```
RTRV-EQPT::S1-OUTC-PG2:SV272:::parameter=OUTESF;
```

which produces the following response:

```
SYMMBITS 04-10-11 10:43:40
M SV272 COMPLD
"S1-OUTC-PG2::OUTESF = Y"
;
```

This response shows that the output framing is set to ESF.

5. Enable the specific port of interest by issuing the TL1 command:

```
ED-SYNC::S1-OUTC-25:SV275::SQUELCH=N;
```

where S1- indicates Expansion shelf 1
OUTC-25 indicates port 25 in output group C
SV275 is the ctag
SQUELCH = N indicates the port is *not* turned off (Y turns off the port)

The system responds with:

```
SYMMBITS 04-10-11 10:52:27  
M SV275 COMPLD  
;
```

To check the setting for a specific output port, issue the TL1 command:

```
RTRV-SYNC::S1-OUTC-25:SV276::PARAMETER=SQUELCH;
```

which produces the following response:

```
SYMMBITS 02-07-11 10:52:27  
M SV276 COMPLD  
"S1-OUTC-25::SQUELCH = N"  
;
```

6. Set the cable compensation for Composite Clock outputs using the procedure in [Configuring CC Signals](#), on page 146.

Securing Cards in the Shelf

Using a Phillips-head or Pozidrive screwdriver, secure all the cards to the shelf by tightening the captive screws at the top and bottom of the card front panels.

Configuring CC Signals

When configured as a Master shelf, the TimeHub 5500 has several capabilities provided to facilitate operation of the shelf with a downstream Remote shelf. These are the ability to phase-align the Master shelf CC outputs to a CC input, and the ability to time-shift (advance or delay) the CC outputs from the Master shelf (which can facilitate cable-delay compensation).

Phase Aligning CC Input and CC Output

The Master shelf can accept a CC input that can be used to phase-align any CC outputs. “Phase-align” means that the bipolar violations are adjusted on the output so that they are phase-matched (time-aligned) to the bipolar violations (same polarity) on the input. The alignment will be to within tens of nanoseconds.



Note: DS1 outputs on the Master shelf are also phase-adjusted during the CC alignment process.

To align CC signals, use the following procedure:

1. Connect the source CC signal to the CC IN 1 input on the Input/Alarm Connector card (see [Figure 2-5](#) for the location of the CC IN 1 connections). This is the signal that the Master shelf will align with. There is no visual indication as to whether the signal you have connected is being received and decoded properly.
2. To activate the alignment, issue the TL1 command:

```
ED-EQPT:::SV277:::CCALIGN=Y;
```

or click the “Align CC Outputs to CC Input” button on the Configuration, Input screen in TimeScan THC.

When CCALIGN is set to Y, all output CC signals are continually aligned with the CC IN 1 input. You can verify that the alignment is occurring by observing the CC input (perhaps another one coming from the same source) and a CC output from the Master shelf on an oscilloscope.

Since the CC signals are balanced and the oscilloscope is a single-ended device, you should make some provision to adapt the signals being observed, such as use of a differential probe or use of an in-line transformer to isolate the balanced and single-ended sides. However, even without these steps a reasonable observation of timing relationship between the two CC signals is usually possible.

If the input and output are not observed to be aligned, possible reasons include:

- The CC input has a problem, such as no signal is present, signal levels are incorrect or it has a formatting problem (such as it does not contain bipolar violations).

- There is a non-zero CC delay enabled on the CC output being observed. This is covered in the next topic, but the easiest thing to do is to temporarily disable the CC delay so that alignment is expected to occur without any timing offset. An alternative is to take into account the CC delay value that has been programmed when observing the timing relationships on the oscilloscope. For example, if a 3 μ s CC delay value has been set (and is enabled), the alignment is successful when you can observe a 3 μ s time difference between the CC input and CC output.
3. Once the phase alignment is as expected, disable the alignment process by issuing the TL1 command

```
ED-EQPT:::SV277:::CCALIGN=N;
```

or clear the “Align CC Outputs to CC Input” button on the Configuration, Input screen in TimeScan THC.

This causes the Master shelf to no longer use the CC IN 1 input as a reference, returning to normal operation using either PRS or DS1 inputs. The Master shelf maintains phase alignment and does not cause the output phase to shift suddenly.

Setting the Delay on CC Outputs

For both Master and Remote shelves, you can apply a timing offset to the CC outputs to compensate for time delay associated with long cable runs. You set the timing offset set in 80-nanosecond increments or in 100-foot increments using TimeScan THC, or using the CCDENB and CBCOMP or CCDEL TL1 keywords.

Each group of 20 ports on each output card group can have a unique delay value. For example, you can assign a CC delay value to the first 20 ports of the “A” output group, a different value to ports 21-40 of the “A” output group, a different value to ports 1-20 of the “B” group, and so on.

Each individual output port can be selected to have the delay feature enabled or disabled. For example, it is possible to delay ports 29 and 30 of a given card group while not delaying any of the other ports in that group. You must enable the delay function for a specific port in order for the delay to apply.

To set the CC delay values using TL1 commands, see [Using TL1 Commands](#), on page 150.

Using TimeScan THC

You set the CC delay parameters on the **Configuration Output** tab in the TimeScan THC application, as shown in [Figure 4-18](#). You set the delay according to the length of cable (in feet) connected to the output.

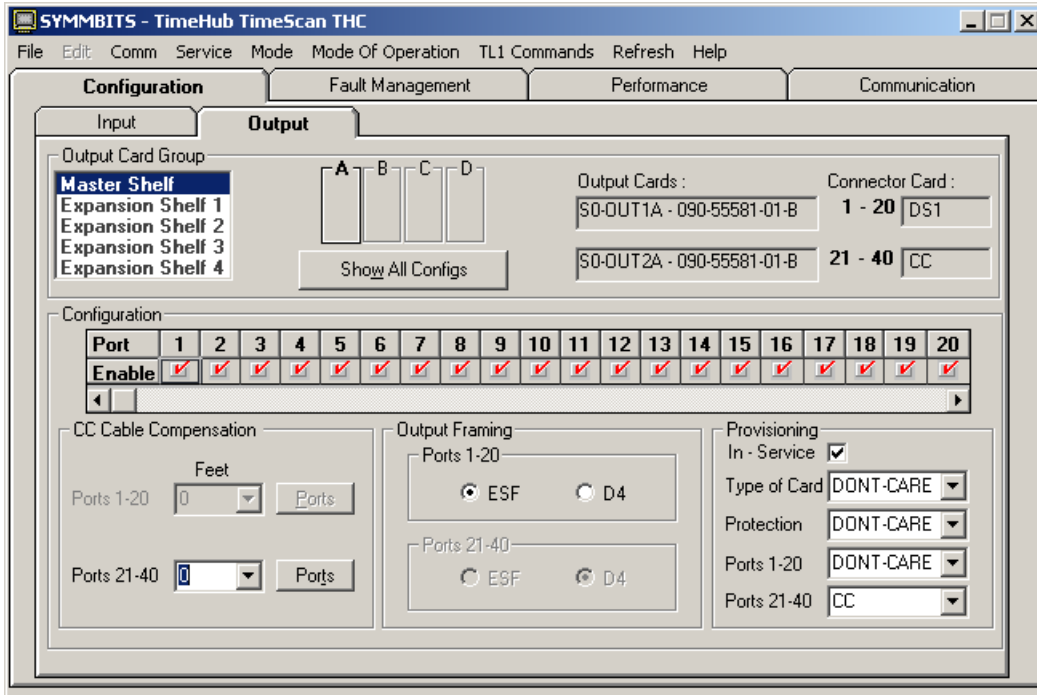

thub0058

Figure 4-18. The Configuration Output Tab

If a CC Output Connector card is installed, the CC Cable Compensation field associated with the card is enabled in the lower left corner.

1. Select the cable length as required using the drop-down list.
2. Click **Ports** to select the ports that will have the compensation applied. A window appears, as shown in [Figure 4-19](#).

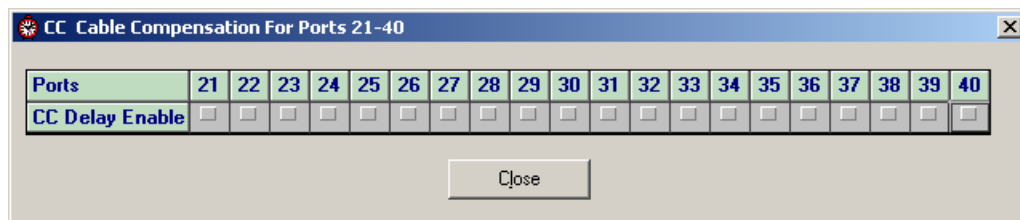

thub0059

Figure 4-19. Enabling Ports for CC Cable Compensation

3. Click the box that correspond to the ports that will have compensation, then click **Close**.

Each individual output port can be selected to have the delay feature enabled or disabled. For example, it is possible to delay ports 29 and 30 of a given card group while not delaying any of the other ports in that group. The CCDENB keyword is used to enable/disable the CC delay capability of individual output ports. See the *TL1 Reference Guide* for details.

Using TL1 Commands

You can set the delay in terms of either feet or time using TL1 commands.

1. Enable a delay on the specified channels by issuing the TL1 command:

```
ED-EQPT::S0-OUTA-PG2:SV278:::CCDENB=Y;
```

This command enables delays on ports 21–40 of Output Group B in the Master shelf.

2. Set a cable length of 100 feet by issuing the TL1 command:

```
ED-EQPT::S0-OUTA-PG2:SV279:::CBCOMP=100;
```

You can also set the delay in terms of time by issuing the TL1 command:

```
ED-EQPT::S0-OUTA-PG2:SV279:::CCDEL=80;
```

Range is ± 10 μ s. A value of 0 means that no additional offset is applied. Positive values delay the CC output by the amount specified. Negative values advance (make earlier in time) the CC output by the specified amount. To compensate for cable delay, use a negative value. For example, if a Master shelf is providing a CC output to a Remote shelf and the cable delay is 1.9 μ s, set the CCDEL value to -1900 (nanoseconds). The alignment of the CC signal(s) at the Remote shelf will be matched with a non-delayed CC output signal generated at the Master shelf.

Checking System Operation

When the signals have been acquired and the outputs are stable enough to output PRS, the TimeHub 5500 enters its normal operation mode. During normal operation, the following conditions exist:

- These should be observed on both Clock cards:
 - Enabled inputs show E LED lit
 - Qualified inputs show Q LED lit
 - The active input reference shows A LED lit
 - One Clock card should have the Active LED lit; the other Clock card has the Standby LED lit
- DS1 and/or CC outputs are functioning according to specifications

Enabling Security

The TimeHub 5500 has a security feature that requires a user to supply a user name and password in order to access or modify parameter settings. Each user can be assigned to one of three different security levels; each level can access system commands that are assigned to corresponding levels.

When security is enabled, a user is required to log on to the system before entering TL1 commands. If security is disabled, logging on is not required. Anyone connecting to the TimeHub can execute any command at any security level.

Factory-set user security levels are described in [Table 4-5](#). Use Edit User Security to change a user's access level.

Table 4-5. User Level and Access

Security Level	Description
User	Users can edit their password and retrieve information, or access any command at the User security level.
Administration	Users are allowed to change configuration and issue User-level commands.
Security	Users are allowed to modify the security database or download new firmware and issue commands at any level.

Factory-set command security levels are described in [Table 4-6](#). The *TL1 Reference Guide* includes the command security levels for each command, and provides information on changing the access level of a command.

Table 4-6. Command Level and Access

Security Level	Description
None	Commands that can be executed without logging on. If the Security Enabled switch (S1-1) on the Management card is off, all commands behave as if their security level were None.
User	Commands that only allow the user to retrieve information.
Administration	Commands that allow the user to change configuration.
Security	Commands that all the user to modify the security database or download new firmware.

To enable security, set switch S1-1 on the Management card to On and a create a user and password.

1. Remove the Management card from the shelf and examine switch S1 (see [Figure 4-2](#)).
2. If the Management card switch S1-1 is set to Off (factory setting), skip to [Step 5](#). If the Management card switch S1-1 is set to On, continue with [Step 3](#).
3. Set switch S1-1 to Off.
4. Install the Management card into its slot (see [Installing the Management Card](#), on page 105).
5. Connect to the TimeHub using a serial connection, as described in [Establishing a Connection to the TimeHub](#), on page 113.
6. Issue the Enter User Security command to add a new user at the Security access level:

```
ENT-USER-SECU:[<tid>]:<aid>:<ctag>::<pid>,,SECURITY;
```

<aid> = User name: up to ten case-insensitive alphanumeric characters

<pid> = User password: up to ten case-sensitive characters. Must include at least two non-alphabetic characters and must include at least one special character: any printing character other than a letter of the alphabet, a number, a comma, a colon, or a semicolon.



Note: For Management cards which contain firmware version 4328D, no special characters are required in the password, but they can be used if desired.



Caution: To avoid a possible service call, do not lose or misplace the user name and password of the security-level user.

7. Remove the Management card.
8. Set Switch S1-1 to On.
9. Install the Management card and tighten the captive screws.
10. Issue the ACT-USR command to log in to the TimeHub:

```
ACT-USR:[tid]:<aid>:<ctag>::<pid>;
```

where <aid> and <pid> are the user name and password, respectively.

Managing the User List

You must be logged in at a Security or Administrator level to add, edit, or delete names from the user list. The list can contain up to 25 names.

Using TimeScan THC

You can manage the user list by selecting **Service, User Administration** from the main menu. The User Administration dialog box appears, as shown in [Figure 4-20](#). You use this dialog box to manage the user list, to force off a logged-on user, or to inhibit access or restore access to a specific user.

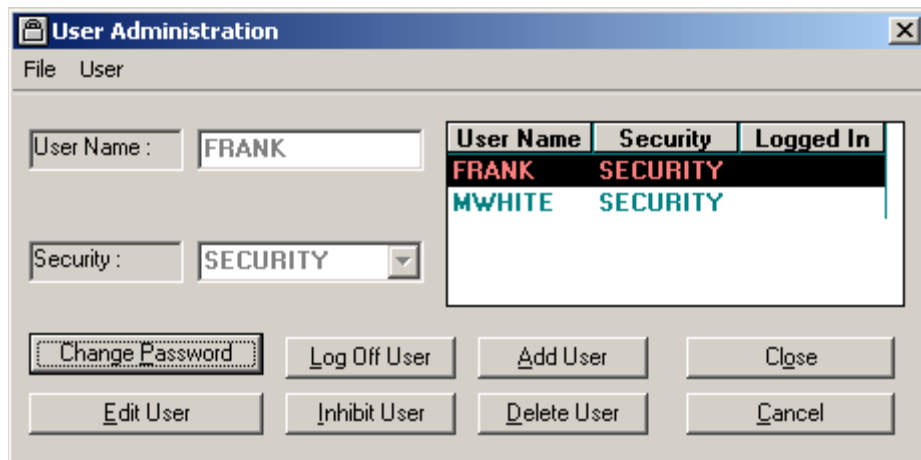

thub0064

Figure 4-20. The User Administration Dialog Box

To add a user to the user list:

1. Click **Add User**.
2. Type a user name (up to 10 case-insensitive characters).
3. Select the security level from the drop-down box.
4. Type a password using up to ten case-sensitive characters. You must include at least two non-alphabetic characters and at least one special character (any printing character other than a letter of the alphabet, a number, a comma, a colon, or a semicolon).
5. Retype the password in the Confirm Password field.
6. Click **Accept**.
7. Click **Close** to close the User Administration dialog box.

To edit a user's security level or password in the user list:

1. Highlight the user name you wish to edit.
2. Click **Edit User**.
3. Change the security level as necessary using the drop-down box.
4. Type the old (current) password for the user in the Password field.
5. Type a new password in the New Password field.
6. Retype the new password in the Confirm Password field.
7. Press **Accept**.
8. Click **Close** to close the User Administration dialog box.

To delete a user from the user list:

1. Highlight the user name you wish to edit.
2. Click **Delete**. A pop-up window requests you to confirm the deletion. Click **OK**.
3. Click **Close** to close the User Administration dialog box.

Using TL1 Commands

To make changes to the user list using TL1 commands, you must issue individual commands.

To add a user to the user list, issue the ENT-USER-SECU command:

```
ED-USER-SECU:[ <tid> ] : <aid> : <ctag> : : <pid> , , <uap> ;
```

where:

<aid> is the new user name

<pid> is the password

<uap> is the security level (USER, SECURITY, or ADMIN)

To change your password, issue the ED-PID command:

```
ED-PID:[ <tid> ] : <aid> : <ctag> : : <oldpid> , <newpid> ;
```

where:

<aid> is your current user name

<oldpid> is your old password

<newpid> is your new password

To edit your user name, password, and access level, issue the ED-USER-SECU command:

```
ED-USER-SECU:[<tid>]:<aid>:<ctag>::<newuid>,<newpid>,,<newuap>;
```

where:

<aid> is your current user name

<newuid> is your new user name

<newpid> is your new password

<newuap> is your new security level (USER, SECURITY, or ADMIN)

To delete a user from the user list, issue the DLT-USER-SECU command:

```
DLT-USER-SECU:[<tid>]:<aid>:<ctag>;
```

where:

<aid> is the user name to be deleted

Setting the Configuration to Factory Defaults

To reset all synchronization-related settings to their factory default settings, use the procedure in this section. All outputs will be disabled; Symmetricom does not recommend that you perform this procedure on a fully operational shelf. Default values are summarized in [Factory Default Values](#), on page 211 and are described completely in the *TL1 Reference Guide*.

To restore synchronization parameters to their factory defaults:

1. Remove the Clock cards from the shelf.
2. On one of the Clock cards, observe the S1 switch 1 position (see [Figure 4-5](#)). Move S1 switch to the opposite position: if it was On, set it to Off; if it was Off, set it to On.
3. Insert this Clock card into the shelf. Wait for it to come out of warm-up.
4. Remove the Clock card and return the S1 switch 1 position to its original position. It should end up in the same position as when you observed it in step 2.
5. Insert this Clock card into the shelf again and wait for it to come out of warm-up. It now contains factory default settings.
6. Insert the second Clock card if there is one. It will receive the factory default settings from the first Clock card.

Chapter 5 Maintaining the TimeHub 5500

This chapter includes:

- [Clearing Output Port Alarms](#)
- [Testing the Cards](#)
- [Troubleshooting the TimeHub 5500](#)
- [Replacing Cards](#)
- [Replacing Fuses](#)
- [Upgrading the Software](#)
- [Returning the TimeHub for Repair](#)
- [Contacting Symmetricom Global Services](#)
- [User Manual Updates](#)

Clearing Output Port Alarms

The TimeHub Output cards contain a sensing circuit that detects output signal failures. Every output port has a sensing circuit. The sensing circuit detects and reports on internal component failures associated with the port output circuitry.

When a port alarm is detected on a given output card, there are several responses:

- For output cards with FPGA version A, the Fail LED on the output card will illuminate. For output cards with FPGA version B or later, the Alarm LED on the output card illuminates. (FPGA version can be seen at the end of output card version information in RTRV-NETTYPE-ALL response).
- An OPPTFLXX (Output Port Fail) event is generated, where XX identifies the specific port number.
- If both output port cards in a redundant pair have detected port alarms on the same port, the OPTALMEXT (“Alarms on same ports - check external conditions”) event will be generated. See a detailed description of this event in the *TL1 Reference Guide*.
- If both output cards in a redundant pair have detected port alarms but not on the same ports, the OPPRFL event is generated. See a detailed description in the *TL1 Reference Guide*.

False Reporting of Output Port Alarms

When you connect an output signal from TimeHub to a single-ended device (such as an oscilloscope or other type of test equipment), it is possible that false port alarms may be reported. This can occur when the connection from the TimeHub differential outputs (Tip and Ring) to the single-ended device (which has signal and ground) is made improperly. Often this connection is made by connecting Tip or Ring to ground (shell of connector on test equipment) and the other signal (the one that was not connected to ground) to the signal input on the test equipment. Connecting in this way creates a path for ground-related noise coming from the test equipment ground (e.g., 60 Hz from utility, ground-loop effects, etc.) to be injected back into the alarm-sensing circuit in TimeHub (via the Tip or Ring that was connected to equipment ground). The result can be that the sensing circuit sees its detection thresholds exceeded (due to the induced noise) and reports a false port alarm.

This situation can also temporarily occur when connecting or disconnecting differentially with test equipment if the connection plug has the possibility of momentarily allowing either of the differential signals to contact the equipment ground. In this case, you can avoid the possible false port alarm by enabling the output only after you complete the physical connection to the test equipment.

Other than the possible alarm reporting, a measurement made with such a connection remains as valid as it would otherwise have been. While such a connection cannot be used in any case to evaluate output signal characteristics such as mask compliance or amplitude levels (because the connection scheme is inherently improper due to direct connection of a signal line ground), it is an acceptable method for basic signal checking such as signal presence. Even though TimeHub may report a port alarm, the TimeHub output signal will still be generated. Also, this connection method will not damage the TimeHub output circuits.

So, while it is acceptable to directly connect as described previously (for limited types of tests), the recommended method for connecting from differential to single-ended is via a transformer, as is expected when connection is made to the equipment that will ultimately be timed by the output. With this type of connection, reporting of false port alarms should not occur.

Clearing False Port Alarms

A false port alarm will normally self-clear when the reason for its occurrence is removed. For example, if a TimeHub ring output connected to test equipment ground is the reason for a false port alarm, removing that connection typically clears the alarm within a few seconds. If the alarm does not self-clear, use the CLRPTALL keyword to request an attempt to clear the alarm (see the *TL1 Reference Guide*, keyword CLRPTALL).

Using TimeScan THC software, the clear attempt can be activated via the following sequence:

1. Select the **Configuration Output** tab ([Figure 5-1](#)) and identify the output card group that is to have port alarm clear attempted. In the example shown, the **C** output group on the Master shelf is selected.
2. Select the **Service, Port Alarm Clear...** menu. A dialog box similar to [Figure 5-2](#) appears.

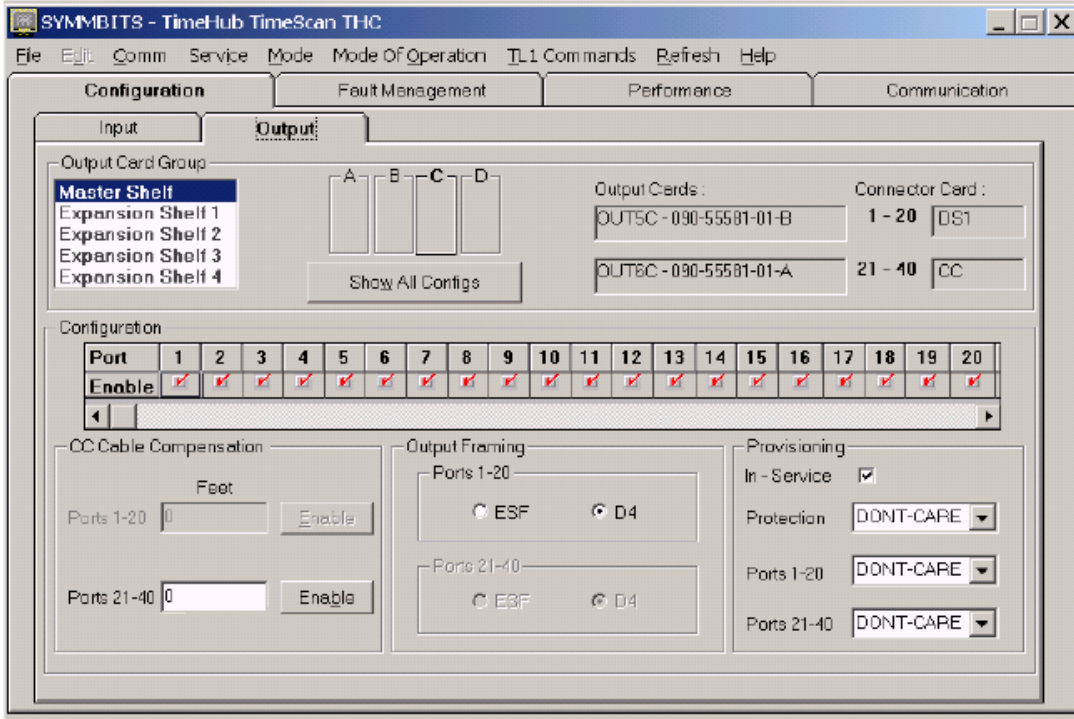

Figure 5-1. The Configuration Output Screen

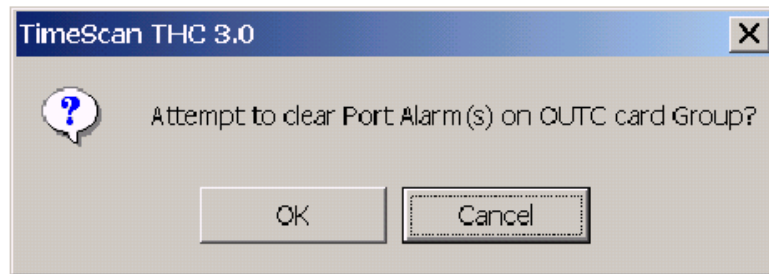

Figure 5-2. Attempt to Clear Port Alarm Query Screen



Note: The screen identifies that the C card group is the target for clearing. Click OK to proceed with the attempt to clear the alarm.



Note: If a false port alarm does not self-clear after the condition causing it is removed, the false alarm was likely generated on only one output card in a redundant pair. This could occur since each card independently senses port alarms and could be impacted slightly differently by injected noise. For example, one card has its sense line near but slightly below the alarm threshold (hence no alarm) and the other card has its sense line near but slightly above the alarm threshold (hence it alarms). When only one card alarms (in a situation where there is a good standby) it effectively remains latched in the alarm state because it disables itself and is no longer able to test for port alarms.

If there is only one output card in the card group (non-redundant), the sensing of a port alarm does not disable the output, hence it continues to sample for the port alarm condition. In this situation the false port alarm will always self-clear if the external cause is removed. Similarly, if the second card in a redundant pair senses a port alarm after the first card has sensed an alarm, the second card does not disable its outputs so it will always self-clear upon removal of the external cause of the false port alarm.

Testing the Cards

The following tests verify that simulated failures generate appropriate alarms. See [Figure 4-3](#) for Management card LEDs, [Figure 4-4](#) for Clock card LEDs, and [Figure 2-4](#) for Output Driver card LEDs.

Reference Switching

To test reference input signal switching, use the following procedure. To perform this test, two enabled and qualified inputs are required.

1. Disconnect the active reference input signal. This is indicated by the lit "INPUTS DS1 A" LED (for example, [Figure 5-3](#) identifies the DS1 Input 1 Active LED).



Note: "E" (Enabled) indicates that this input is allowed to become active, "Q" (Qualified) indicates the input is qualified for use, and "A" (Active) indicates the input is the reference being used to drive the outputs.

Requirements: on both Clock cards:

- The DSI Q and A LEDs for the disconnected reference input signal turn off. E remains lit, indicating that this input will continue to attempt input qualification (which it cannot do because of LOS).
- The DS1 A LEDs for the reference input signal now being tracked light.
- The Alarm LEDs light.
- On the Management card, the Shelf Minor Alarm LED lights. This alarm is caused by an enabled input that is not qualified (INDISQ). Specific alarm information is logged on each clock card and automatically output on communication ports.

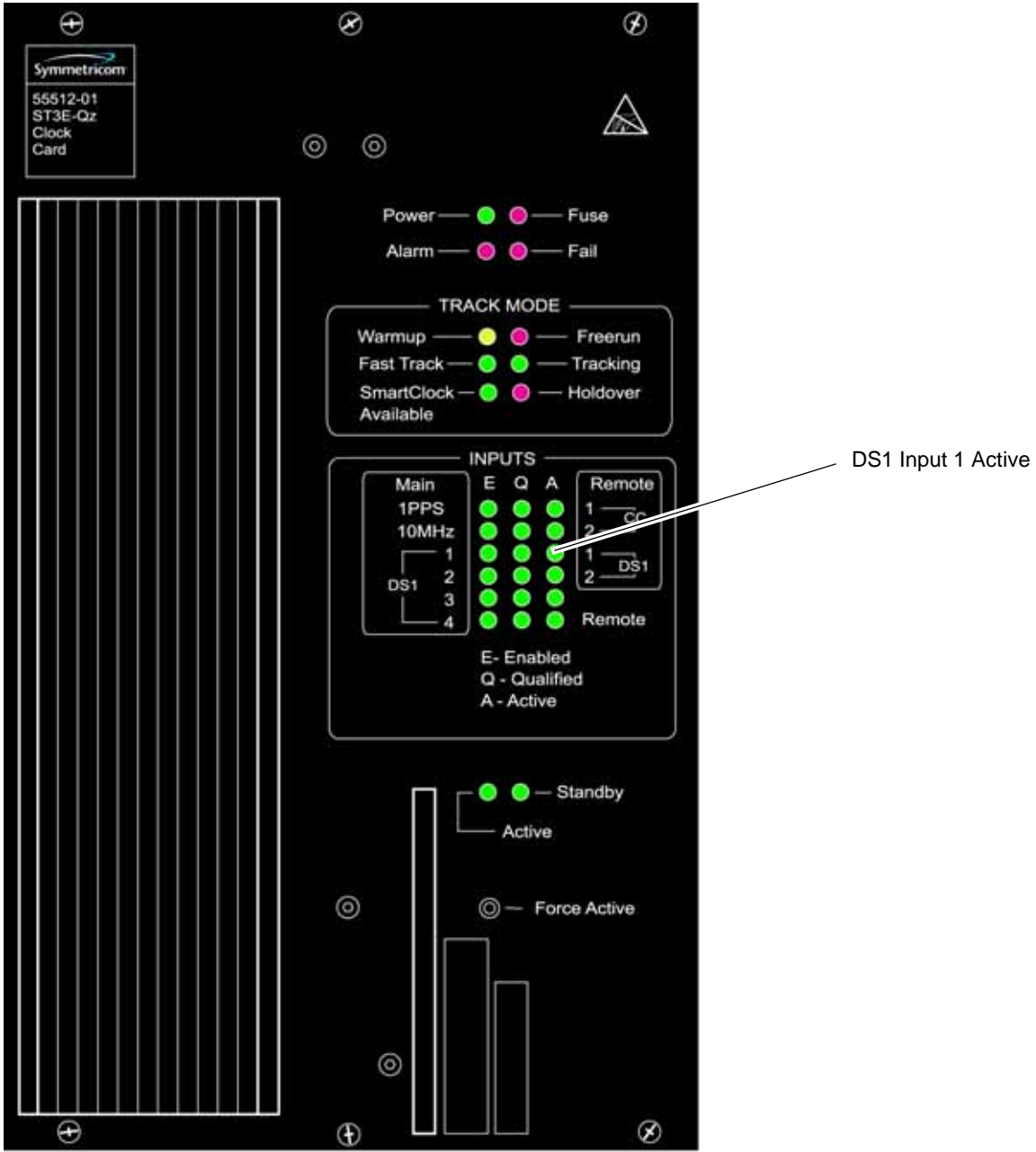

thub0009

Figure 5-3. Active DS1 Input Signal Indication

2. Reconnect the reference input signal disconnected in Step 1, and wait at least 3 minutes for the signal to requalify.

Requirements: on both Clock cards:

- The DS1 Q and A LEDs for the reconnected reference input signal light.
- The DS1 A LEDs for the reference input signal no longer being tracked turn off.
- The Alarm LEDs turn off.

Removing a Clock Card

To test which alarms result from active Clock card failure, use the following procedure.

1. Remove the Clock card with the Active LED lit.

Requirements:

- On the remaining Clock card in the shelf, the Standby LED turns off. and the Active LED lights.
- On the Management card, the Shelf Major alarm LED lights.

2. Install the Clock card removed in Step 1, and wait for it to enter, then exit warmup (as indicated by the LED). The Freerun LED lights.

Requirements: On the Clock card just installed:

- The Standby LED lights.
- The remaining LEDs are the same as the other Clock card.
- The shelf major alarm turns off on the Management card.

3. Press the Force Active pushbutton on the re-installed Clock card to make it the active Clock card.

Requirement: The Active LED lights on the re-installed Clock card.

Troubleshooting the TimeHub 5500

The figures and tables in this section provide troubleshooting actions for the TimeHub 5500 using the LEDs on the front panel of the Clock, Output Driver, Management, and EC cards.

Troubleshooting the Clock Card

The front panel of the Clock card is shown in [Figure 5-4](#). Use the LEDs on the front panel and the actions in [Table 5-1](#) to diagnose and resolve problems with the Clock card.

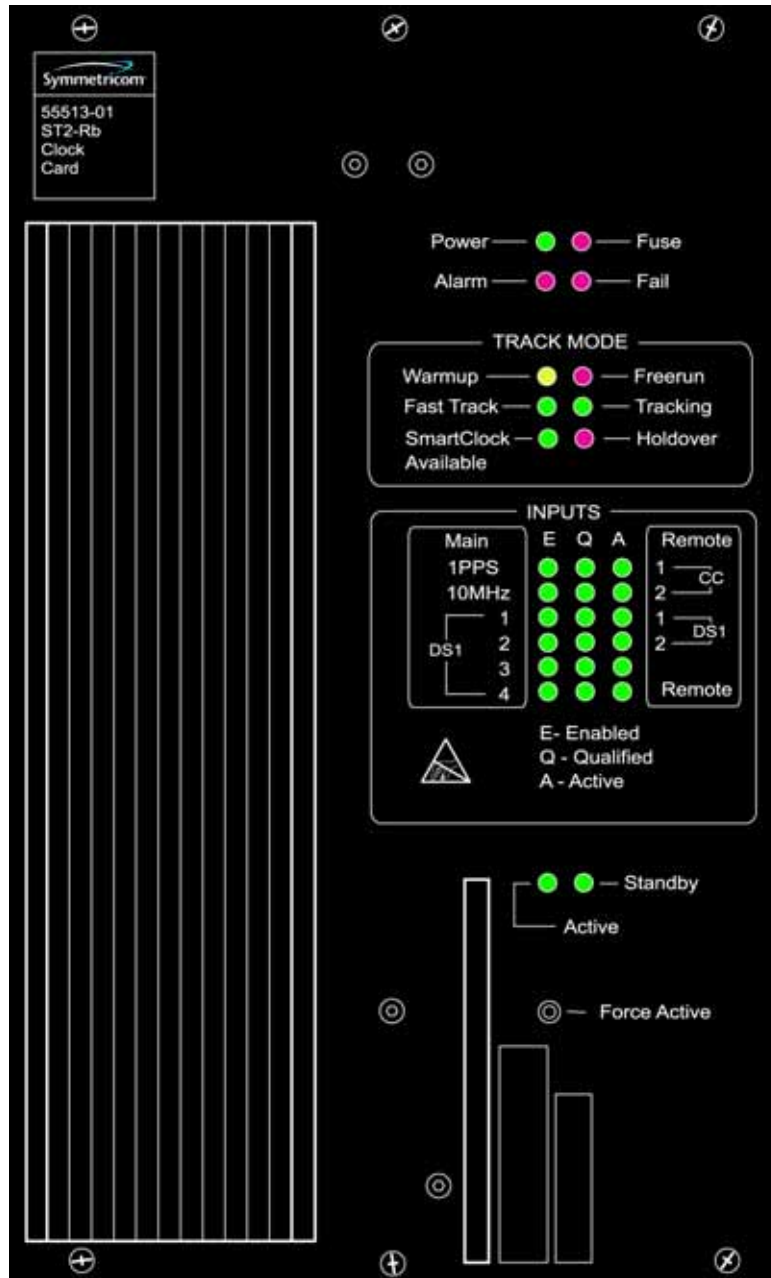

thub0010

Figure 5-4. Front Panel of the Clock Card

Table 5-1. Troubleshooting the Clock Card Front Using the LEDs

Name	State	Description	Action
Power	Off	Power is not present.	<ol style="list-style-type: none"> 1. If all LEDs on the shelf are off, apply power or troubleshoot the –48 V power source. 2. If all LEDs on the Clock card are off, replace the card as described in Replacing the Clock Card, on page 185. 3. If the Fuse LED is lit, replace the fuse as described in Replacing the Fuse in the Clock Card, on page 188. 4. If the replacement fuse fails, replace the card as described in Replacing the Clock Card, on page 185.
	Green	Power is present.	None required.
Fuse	Off	The Clock card fuse is not open.	None required.
	Red	The Clock card fuse is open.	<ol style="list-style-type: none"> 1. Replace the fuse as described in Replacing the Fuse in the Clock Card, on page 188. 2. If the replacement fuse fails, replace the card as described in Replacing the Clock Card, on page 185.
Alarm	Off	There is no alarm condition.	None required.
	Red	An alarm condition exists.	If the Fail LED is also lit, replace the card as described in Replacing the Clock Card , on page 185. If the Fail LED is not lit, check the Clock card LEDs and other card LEDs, and/or troubleshoot the error message(s) to determine the cause of the alarm. Refer to the <i>TL1 Reference</i> for details on error messages.
Fail	Off	No hardware or firmware failure has occurred on the Clock card.	None required.
	Red	A hardware or firmware failure has occurred on the Clock card.	Replace the card as described in Replacing the Clock Card , on page 185.

Table 5-1. Troubleshooting the Clock Card Front Using the LEDs (Continued)

Name	State	Description	Action
TRACK MODE Warmup	Off	The Clock card is not in a warm-up state.	None required.
	Yellow	The Clock card is warming up, and the card is not yet active.	None required.
TRACK MODE Freerun	Off	The Clock card is not in a freerun state.	None required.
	Red	The Clock card is generating an output without using any tracking information from a reference source.	<p>Check whether both Clock cards are in Freerun. If both cards are in Freerun, troubleshoot the input signal source.</p> <p>If only one card is in Freerun:</p> <ol style="list-style-type: none"> 1. Ensure that the Clock card still qualifying input signals is the active card. (Use the Force Active pushbutton if needed.) 2. If the Clock card entered Freerun because the performance measurements disqualified the inputs, click Clear on the Performance tab of THC or use the INIT-REG command to clear the performance measurements for each disqualified input. Refer to the TL1 Reference for details on the INIT-REG command.
TRACK MODE Tracking	Off	The Clock card is not tracking a qualified input.	Check the state of the other TRACK MODE (Warmup, Freerun, Fast Track, Smart Clock Available, Holdover) LEDs. Troubleshoot the other TRACK MODE LED(s) per this table.
	Green	The Clock card is tracking a qualified input.	None required.
TRACK MODE Fast Track	Off	The Clock card is not in a fast track state.	None required.
	Green	The Clock card has warmed up, is tracking, and is providing a usable output, but has not yet achieved Smart Clock (optimal quality) output.	None required.

Table 5-1. Troubleshooting the Clock Card Front Using the LEDs (Continued)

Name	State	Description	Action
TRACK MODE Smart Clock Available	Off	The system has not gathered sufficient information during tracking to provide Smart Clock (optimal quality) holdover output if necessary.	None required if the system has been in fast track for less than 32 hours. If the system has been in fast track for more 32 hours, troubleshoot the input signal source.
	Green	The system has gathered sufficient information during tracking to provide SmartClock (optimal quality) holdover output if necessary.	None required.
TRACK MODE Holdover	Off	The system is not in Holdover.	None required.
	Red	All inputs are lost or unacceptable, and the system is now using the internal oscillator which is using recent tracking data from a qualified reference to provide the output.	Check whether both Clock cards are in Holdover. If both cards are in Holdover, troubleshoot the input signal source. If only one card is in Holdover: <ol style="list-style-type: none"> 1. Ensure that the Clock card still qualifying input signals is the active card. 2. If the Clock card entered Holdover because the performance measurements disqualified the inputs, click Clear on the Performance tab of THC or use the INIT-REG command to clear the performance measurements for each disqualified input. Refer to the TL1 Reference Guide for details on the INIT-REG command.
INPUTS E	Off	The associated reference input is not enabled (E) for tracking.	None required. If desired, enable the reference input using the Edit Sync command (refer to the <i>TL1 Reference Guide</i> for details).
	Green	The associated reference input is enabled (E) for tracking.	None required.

Table 5-1. Troubleshooting the Clock Card Front Using the LEDs (Continued)

Name	State	Description	Action
INPUTS Q	Off	The associated reference input is not qualified (Q) for tracking.	<p>If the INPUTS E LED is off or if the Warmup LED is lit, none required.</p> <p>If the Freerun LED is lit longer than 1 minute, troubleshoot the input signal source.</p> <p>If the INPUTS Q LED is lit on the other Clock card over 200 s:</p> <ol style="list-style-type: none"> 1. Remove, then insert this card as described in Replacing the Clock Card, on page 185. 2. Replace this card as described in Replacing the Clock Card, on page 185.
	Green	The associated reference input is qualified (Q) for tracking.	None required.
INPUTS A	Off	The associated reference input is not being actively (A) used for tracking.	None required.
	Green	<p>The associated reference input is being actively (A) used for tracking.</p> <p>In a remote system , this light indicates the shelf being configured as a remote shelf. In this case, the corresponding 'Q' and 'E' lights are off.</p>	None required.
Active	Off	This card is not the synchronization signal source for all output cards.	<p>If the Standby LED on this card is lit, none required. If the Standby LED on this card is also off:</p> <ol style="list-style-type: none"> 1. If the Fail LED is lit, replace the card; if the Fail LED is off, remove, then insert the card as described in Replacing the Clock Card, on page 185. 2. Once the Freerun LED is lit, if the Active LED is still off, replace the card as described in Replacing the Clock Card, on page 185.
	Green	This card is the synchronization signal source for all output cards.	None required.

Table 5-1. Troubleshooting the Clock Card Front Using the LEDs (Continued)

Name	State	Description	Action
Standby	Off	This card is not generating an output that is phase-locked to the output of the other (active) Clock card.	If the Active LED on this card is lit, none required. If the Active LED on this card is also off: <ol style="list-style-type: none"> 1. If the Fail LED is lit, replace the card; if the Fail LED is off, remove, then insert the card as described in Replacing the Clock Card, on page 185. 2. If the Standby LED is still off, replace the card as described in Replacing the Clock Card, on page 185.
	Green	This card is generating an output that is phase-locked to the output of the other (active) Clock card.	None required.
Force Active (Pushbutton)	–	When pressed, this pushbutton forces the card to be the active card.	–

SNDRIFT Events

In addition to the LEDs, the events and alarms are useful in diagnosing Clock card issues. One event, SNDRIFT, provides an indication that the frequency relationship between the indicated input and clock module internal reference oscillator is exhibiting a larger amount of drift (frequency change vs. time) than would normally be expected. For example, the event shown below indicates that the frequency relationship between the CLK2 internal reference oscillator (CLK2 indicated in beginning of response) and input 1 (this is the 1 in CLK2-1) is drifting more than expected.

```
"CLK2-1,T1:MN,SNDRIFT,NSA,10-17,06-56-57:\\"Drift Exceeds Limits\\""
```

The drift limits are based on GR-1244 holdover frequency stability requirements (see section 5 in GR-1244). These requirements are specifications for the stand-alone stability of the internal reference oscillator, which cannot be self-measured by the TimeHub shelf during normal operation. The TimeHub measures the drift relationship between every input and the internal reference oscillator, which is what is measured and used in the SNDRIFT assessment. Since this measurement is a combination of both the drift of the input and the internal reference oscillator, it is not a direct assessment vs. the GR-1244 specification described above (which is only about the internal reference). However, if the combined relative drift of input and internal oscillator exceeds these thresholds it could be an indication that there is an issue with either the input or internal reference oscillator. The Timehub does not disqualify the input when this condition is reported since it doesn't necessarily indicate that anything is out of spec.

If an SNDRIFT event(s) occur, the following considerations can be helpful in determining what action, if any, you should take:

- If there is more than one input enabled, is the SNDRIFT event reported for more than one input?
 - If yes, and assuming that the inputs are from independent synchronization paths, this could be an indication that the internal reference oscillator in the clock module is drifting. The reasoning is that the internal reference oscillator is common to all the measurements; it is unlikely that independent inputs would all be drifting.
 - If no, it is likely that the input is drifting.
- Does the other clock card report the same condition?
 - If yes, it is likely that the input is drifting. The clock cards independently assess the inputs. It is unlikely that internal reference oscillators in both clock cards are drifting; hence the input is the likely drift source.
 - If no, it is likely that the internal reference oscillator is drifting on the clock that is reporting SNDRIFT. There are some special considerations here:

If one clock is stratum 3E (55512-02) and the other is stratum 2 (55514-02) the drift limits are different (1E-9 vs. 1E-10 per day) so it is reasonable that the stratum 2 clock reports a drift event while the stratum 3E clock does not due to the tighter limits in the stratum 2 clock. In this case, the stratum 2 clock should not be particularly suspected since the input could be drifting in the 1E-10 to 1E-9 per day range. On the other hand, if the stratum 3E clock reports SNDRIFT but the stratum 2 clock does not, that would be an indication of possible drift problems on the internal reference oscillator in the stratum 3E clock.

The drift assessment is based on long-term observation of the reference clock - input frequency relationship. Each clock re-assesses vs. the drift thresholds every 8 hours. Since the clocks are independent, they are generally not on the same 8-hour schedule, so it is likely that the clock cards would not report SNDRIFT at the same time. Hence, one clock card might report a drift alarm up to 8 hours before the other one also reports it.

Because the SNDRIFT event is a long-term assessment, the potential for setting or clearing of the SNDRIFT event is at 8-hour intervals. Hence, a sudden change of drift on an input will not result in an immediate reporting of SNDRIFT, but could affect the next update (up to 8 hours later).

Use the decision tree in [Figure 5-5](#) to resolve a persistent SNDRIFT event. An occasional SNDRIFT event could occur on a Clock card due to external temperature variations or, in rare cases, a frequency hop. The following decision tree is for an SNDRIFT situation that persists for several days, or comes and goes repeatedly.

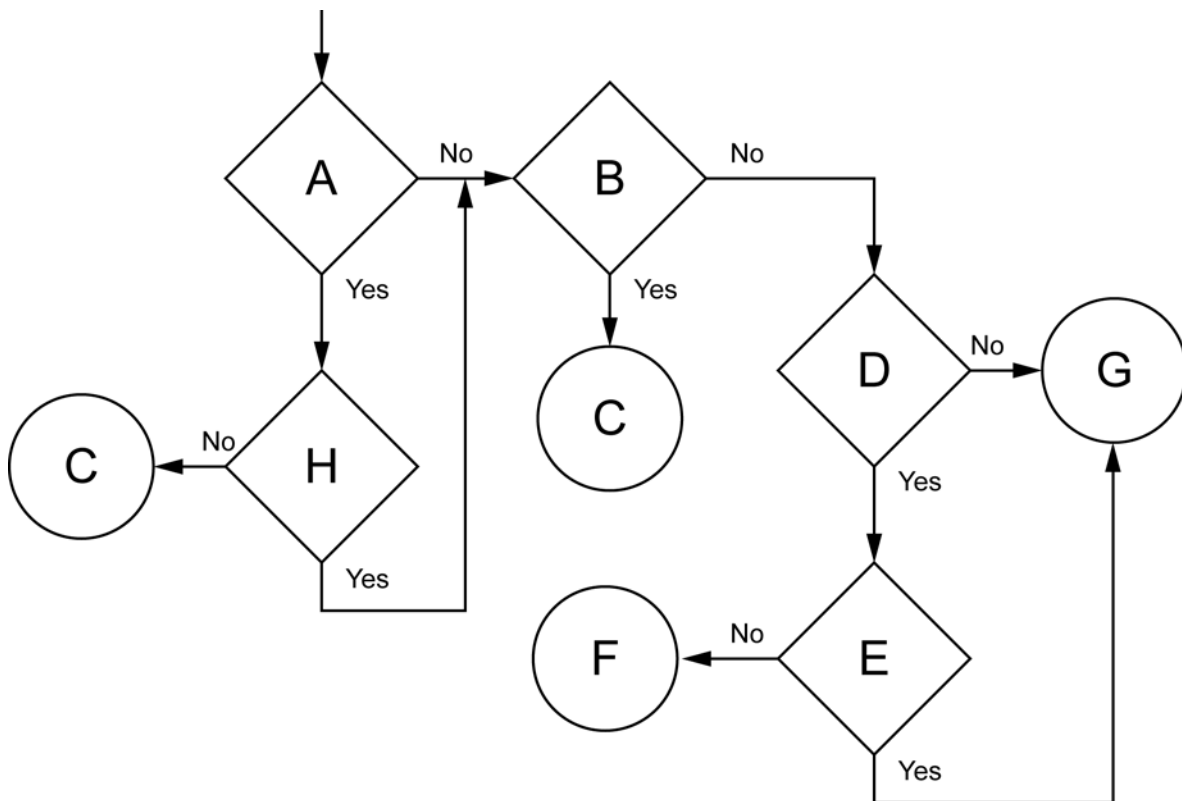

- A. Is more than one input being used for timing?
- B. Are both Clock cards reporting SDRIFT?
- C. The input is a likely reason for SDRIFT. Analyze the input for excessive drift, which can eventually result in disqualification. The SDRIFT provides a potential early diagnostic.
- D. Is one Clock card ST2 (Rb) and the other Clock card ST3E (Qz)?
- E. Is the ST3E (Qz) Clock card reporting SDRIFT?
- F. The input is likely drifting more than ST2 rate but less than ST3E rate.
- G. The reference oscillator in the Clock card reporting SDRIFT is drifting more than expected. Replace the Clock card as described in [Replacing the Clock Card](#), on page 185.
- H. Are all inputs reporting SDRIFT?

Figure 5-5. SDRIFT Decision Tree

Troubleshooting the Output Driver Card

The front panel of the Output Driver card is shown in [Figure 5-6](#). Use the LEDs on the front panel and the actions in [Table 5-2](#) to diagnose and resolve problems with the Output Driver card.



Figure 5-6. Front Panel of the Output Driver Card

Table 5-2. Troubleshooting the Output Driver Card Using Front Panel LEDs

Name	State	Description	Action
Power	Off	Power is not present.	<ol style="list-style-type: none"> 1. If all LEDs on the system are off, apply power or troubleshoot the –48 V power source. 2. If all LEDs on the Output Driver card are off, replace the card as described in Replacing the Output Driver Card, on page 186.
	Green	Power is present.	None required.
Fuse	Off	The Output Driver card fuse is not open.	None required.
	Red	The Output Driver card fuse is open.	<ol style="list-style-type: none"> 1. Replace the fuse as described in Replacing the Fuse in the Output Driver Card, on page 190. 2. If the replacement fuse fails, replace the card as described in Replacing the Output Driver Card, on page 186.
Alarm	Off	There is no alarm condition.	None required.
	Red	An alarm condition exists.	<p>If the Fail LED is also lit, replace the card as described in Replacing the Output Driver Card, on page 186. If not, check the Output Driver card LEDs and other card LEDs, and/ or troubleshoot the error message(s) to determine the cause of the failure. Refer to the <i>TL1 Reference Guide</i> for details on error messages.</p> <p>General reasons why the Alarm LED could be uniquely lit:</p> <ol style="list-style-type: none"> 1. If the card has never been initialized, this LED remains lit, possibly indicating a communication problem since the active Clock card should perform the initialization. If there is no Clock card in the shelf the output card would not be expected to initialize and the LED would remain lit.

Table 5-2. Troubleshooting the Output Driver Card Using Front Panel LEDs (Continued)

Name	State	Description	Action
Alarm (cont'd)			<p>2. If the Output card contains FPGA version B or later the Alarm LED lights if there is a port alarm detected. For details, see Clearing Output Port Alarms, on page 158. The current FPGA version appears at the end of output card version information in RTRV-NETTYPE-ALL response.</p> <p>3. The Alarm LED lights if the Output Driver card is using the Clock signal from the standby clock. While this is a perfectly good clock to use, it should normally use the clock signal from the Active clock. If this is the cause of the alarm, it could signify a problem with the Active clock, the backplane connection, or this output card. If this is the cause of the Alarm, the OSTBYCLK (Output using STandBY CLock) event is generated.</p> <p>See also Clearing Output Port Alarms, on page 158.</p>
Fail	Off	No hardware or firmware failure has occurred on the Output Driver card.	None required.
	Red	A hardware or firmware failure has occurred on the Output Driver card.	<p>The Fail LED could be uniquely lit for the following reasons:</p> <ol style="list-style-type: none"> 1. The card has an internal hardware failure. 2. The card has been initialized and is not currently receiving a valid clock signal. This can occur if there are no Clock cards in the shelf (or they are still in warmup): the Fail LED on all Output Driver cards in the shelf are lit. 3. If the Output Driver card contains FPGA version A, the Fail LED lights if a port alarm is detected. To clear the alarm, see Clearing Output Port Alarms, on page 158. To check the firmware version, see Reading the Output Driver Firmware Version, on page 175.

Table 5-2. Troubleshooting the Output Driver Card Using Front Panel LEDs (Continued)

Name	State	Description	Action
Ports 1–20 DS1	Off	There is no Output Connector card connected to ports 1 through 20; no outputs can be generated.	None required.
	Green	There is a DS1 Output Connector card connected to ports 1 through 20.	None required.
Ports 1–20 CC	Off	There is no Output Connector card connected to ports 1 through 20; no outputs can be generated.	None required.
	Green	There is a CC Output Connector card connected to ports 1 through 20.	None required.
Ports 21–40 DS1	Off	There is no Output Connector card connected to ports 21 through 40, no outputs can be generated.	None required.
	Green	There is a DS1 Output Connector card connected to ports 21 through 40.	None required.
Ports 21–40 CC	Off	There is no Output Connector card connected to ports 21 through 40, no outputs can be generated.	None required.
	Green	There is a CC Output Connector card connected to ports 21 through 40.	None required.

Reading the Output Driver Firmware Version

To check the firmware version of an Output Driver Card, issue the RTRV-NETTYPE-ALL command and observe the response lines associated with Output Driver cards, each of which contains firmware version information. For example, the command

```
RTRV-NETTYPE-ALL:::SC1;
```

produces the following response:

```
SYMMBITS 99-10-03 20:55:19
M sc1 RTRV
"TSG:Symmetricom,5500,TSG"
"S0-IMC: ,090-55542-01-A, ,W0320A,J20280,D0TPN0JAAA,297085"
"S0-CLK1: ,090-55512-01-A, ,R4209A,0000000,D0TPVPJAAA,296936"
"S0-CLK2: ,090-55514-01-A, ,R4209A,0000000,D0TPKPJAAA,296939"
"S0-OUT5C: ,090-55581-01-A, ,R4209A,00J21559,D0TPJN0AAA,267799,DS1, "
"S0-OUT6C: ,090-55581-01-A, ,R4114C,00J43212,D0TPJN0AAA,267799,DS1, "
>
```

```
SYMMBITS 99-10-03 20:55:19
M sc1 COMPLD
"S2-CLK1: ,090-55545-01-B, ,4209A, ,D0C1ZZ0AAA,299465"
"S2-CLK2: ,090-55545-01-B, ,4209A, ,D0C1ZZ0AAA,299465"
"S2-OUT12F: ,090-55581-01-A, ,R4209A,00000000,D0TPJN0AAA,267799, , "
"S2-OUT14G: ,090-55581-01-A, ,R4114C,00J21577,D0TPJN0AAA,267799,DS1,DS1"
```

In the above response, four output cards are identified. The lines starting with S0-OUT5C and S0-OUT6C identify output cards in slots 5 and 6 of the Master shelf. The firmware version of the Output cards is shown in bold type on each of these lines. The card in slot 5C contains R4209A so it will work in Expansion shelf slot 16H. The card in slot 6C contains R4114C, it must be upgraded if you plan to use it in Expansion shelf slot 16H.

The second section of responses shows cards in the Expansion shelf (configured with the rotary switch set to 2). This Expansion shelf has Output Driver cards in locations 12F and 14G. The card in slot 14G contains firmware version R4114C; it must be upgraded before it can be used in slot 16H.



Note: If the Management card contains firmware version 4328D, the Expansion Controller cards are identified by the AIDs ECC1 and ECC2 instead of CLK1 and CLK2. The Clock cards on the main shelf use the AIDs CLK1 and CLK2.

Troubleshooting the Management Card

The front panel of the Management card is shown in [Figure 5-7](#). Use the LEDs on the front panel and the actions in [Table 5-3](#) to diagnose and resolve problems with the Management card.

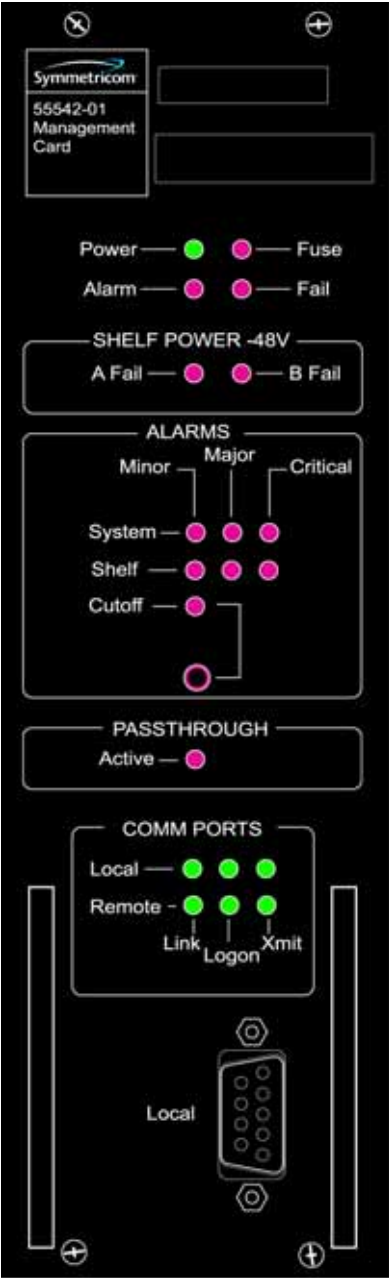

thub0008

Figure 5-7. Front Panel of the Management Card

Table 5-3. Management Card Front Panel Items

Name	State	Description	Action
Power	Off	Power is not present.	<ol style="list-style-type: none"> 1. If all LEDs on the system are off, apply power or troubleshoot the –48 V power source. 2. If all LEDs on the Management card are off, replace the card as described in Replacing the Management Card, on page 186.
	Green	Power is present.	None required.
Fuse	Off	The Management card fuse is not open.	None required.
	Red	The Management card fuse is open.	<ol style="list-style-type: none"> 1. Replace the fuse as described in Replacing the Fuse in the Management Card, on page 189. 2. If the replacement fuse fails, replace the card as described in Replacing the Management Card, on page 186.
Alarm	Off	There is no alarm condition.	None required.
	Red	An alarm condition exists.	If the Fail LED is also lit, replace the card as described in Replacing the Management Card , on page 186. If not, check the Management card LEDs and other card LEDs, and/or troubleshoot the error message(s) to determine the cause of the failure. Refer to the <i>TL1 Reference Guide</i> (see RTRV-ALM) for details on error messages.
Fail	Off	No hardware or firmware failure has occurred on the Management card.	None required.
	Red	A hardware or firmware failure has occurred on the Management card.	Replace the card as described in Replacing the Management Card , on page 186.
SHELF POWER –48V A Fail	Off	The –48V A input is at the normal voltage level.	None required.
	Red	The –48V A input is below the normal voltage level.	Troubleshoot and repair the A –48 V battery input.

Table 5-3. Management Card Front Panel Items (Continued)

Name	State	Description	Action
SHELF POWER –48V B Fail	Off	The –48V B input is at the normal voltage level.	None required.
	Red	The –48V B input is below the normal voltage level.	Troubleshoot and repair the B –48 V battery input.
ALARMS System Minor	Off	There is no minor alarm outside the shelf.	None required.
	Red	A minor alarm condition exists outside the shelf.	Refer to the <i>TL1 Reference Guide</i> (see RTRV-ALM) to determine which minor alarm occurred and the recommended action.
ALARMS System Major	Off	There is no major alarm outside the shelf.	None required.
	Red	A major alarm condition exists outside the shelf.	Refer to the <i>TL1 Reference Guide</i> (see RTRV-ALM) to determine which major alarm occurred and the recommended action. If a minor system alarm is also present, it does not appear on the front panel LEDs because only the highest severity alarm of a group (system or shelf) is illuminated. When the major system alarm ends, the minor system alarm LED then lights.
ALARMS System Critical	Off	There is no critical alarm outside the shelf.	None required.
	Red	A critical alarm condition exists outside the shelf.	Refer to the <i>TL1 Reference Guide</i> (see RTRV-ALM) to determine which critical alarm occurred and the recommended action. If a major and/or minor system alarm is present, it does not appear on the front panel LEDs because only the highest severity alarm of a group (system or shelf) is illuminated. When the critical system alarm ends, the LED associated with the highest-severity remaining system alarm LED then lights.

Table 5-3. Management Card Front Panel Items (Continued)

Name	State	Description	Action
ALARMS Shelf Minor	Off	There is no minor alarm within the shelf.	None required.
	Red	A minor alarm condition exists in the shelf.	Refer to the <i>TL1 Reference Guide</i> (see RTRV-ALM) to determine which minor alarm occurred and the recommended action.
ALARMS Shelf Major	Off	There is no major alarm within the shelf.	None required.
	Red	A major alarm condition exists in the shelf.	Refer to the <i>TL1 Reference Guide</i> (see RTRV-ALM) to determine which major alarm occurred and the recommended action. If a minor shelf alarm is present, it does not appear on the front panel because only the highest severity alarm of a group (system or shelf) is illuminated. When the major shelf alarm ends, the minor shelf alarm LED then lights.
ALARMS Shelf Critical	Off	There is no critical alarm within the shelf.	None required.
	Red	A critical alarm condition exists in the shelf.	Refer to the <i>TL1 Reference Guide</i> (see RTRV-ALM) to determine which critical alarm occurred and the recommended action. If a major and/or minor shelf alarm is present, it does not appear on the front panel LEDs because only the highest severity alarm of a group (system or shelf) is illuminated. When the critical shelf alarm ends, the LED associated with the highest-severity remaining shelf alarm LED then lights.
AUDIBLE ALARMS Cutoff (LED)	Off	The alarm cutoff function has not been activated.	None required. Press the ALARMS Cutoff pushbutton to silence all audible alarms.
	Red	An audible or visible alarm was present. The audible alarm has been silenced, but the alarm condition still exists.	None required.

Table 5-3. Management Card Front Panel Items (Continued)

Name	State	Description	Action
AUDIBLE ALARMS Cutoff (Pushbutton)	–	Silences all audible alarms when pressed.	None required.
PASS THROUGH Active	Off	The Management card is not supplying the output frequency to the Clock cards.	None required.
	Red	Both Clock cards are malfunctioning, and the Management card is supplying the output frequency.	Troubleshoot the Clock cards as described in Troubleshooting the Clock Card, on page 164 .
COMM PORTS Local Link	Off	The local communication port is disabled.	If no physical connection exists, none required. If a physical connection exists, troubleshoot the cable connection.
	Green	The local communication port is enabled.	None required.
COMM PORTS Local Logon	Off	A user is not logged on the local port.	None required.
	Green	A user is logged on the local port.	None required.
COMM PORTS Local Xmit	Off	Data is not being transferred on the local port.	None required.
	Green	Data is being transferred on the local port.	None required.
COMM PORTS Remote Link	Off	The network connection is disabled.	If no physical connection exists, none required. If a physical connection exists, troubleshoot the cable connection.
	Green	The network connection is enabled.	None required.
COMM PORTS Remote Logon	Off	A user is not logged on the network.	None required.
	Green	A user is logged on the network.	None required.
COMM PORTS Remote Xmit	Off	Data is not being transferred on the network.	None required.
	Green	Data is being transferred on the network.	None required.

Troubleshooting the Expansion Controller Card

The front panel of the Expansion Controller card is shown in [Figure 5-8](#). Use the LEDs on the front panel and the actions in [Table 5-4](#) to diagnose and resolve problems with the EC card.



Figure 5-8. Front Panel of the Expansion Controller Card

Table 5-4. Troubleshooting the Expansion Controller Card

Name	State	Description	Action
Power	Off	Power is not present.	<ol style="list-style-type: none"> If all LEDs on the system are off, apply power or troubleshoot the –48 V power source. If all LEDs on the EC card are off, replace the card as described in Replacing the Expansion Controller Card, on page 187.
	Green	Power is present.	None required.
Fuse	Off	The EC card fuse is not open.	None required.
	Red	The EC card fuse is open.	<ol style="list-style-type: none"> Replace the fuse as described in Replacing the Fuse in the EC Card, on page 191. If the replacement fuse fails, replace the card as described in Replacing the Expansion Controller Card, on page 187.
Shelf Alarm	Off	There is no alarm condition.	None required.
	Red	An alarm condition exists.	If the Fail LED is also lit, replace the card as described in Replacing the Expansion Controller Card , on page 187. If not, check the EC card LEDs and other card LEDs, and/or troubleshoot the error message(s) to determine the cause of the failure. Refer to the <i>TL1 Reference Guide</i> for details on error messages.
Fail	Off	No hardware or firmware failure has occurred on the EC card.	None required.
	Red	A hardware or firmware failure has occurred on the EC card.	Replace the card as described in Replacing the Expansion Controller Card , on page 187.
SHELF POWER –48V A Fail	Green	The –48V A input is at the normal voltage level.	None required.
	Red	The –48V A input is below the normal voltage level.	Troubleshoot and repair the A –48 V battery input.
SHELF POWER –48V B Fail	Green	The –48V B input is at the normal voltage level.	None required.
	Red	The –48V B input is below the normal voltage level.	Troubleshoot and repair the B –48 V battery input.

Table 5-4. Troubleshooting the Expansion Controller Card

Name	State	Description	Action
Expansion Link 1	Off	The link 1 cable is not connected.	Connect the link 1 cable.
	Red	The link 1 cable is attached, but there is a problem receiving either clock timing, clock framing, or communication from the master shelf.	Check clock timing, clock framing, and communication on the Master shelf.
	Green	EC card is receiving proper timing, framing, and communication from the master shelf.	None required.
Expansion Link 2	Off	The link 2 cable is not connected.	Connect the link 2 cable.
	Red	The link 2 cable is attached, but there is a problem receiving either clock timing, clock framing, or communication from the master shelf.	Check clock timing, clock framing, and communication on the Master shelf.
	Green	EC card is receiving proper timing, framing, and communication from the master shelf.	None required.

Replacing Cards

Replacing the Clock Card



Warning: Before replacing the Clock card, make sure that the system has at least one clock active and is NOT operating in Passthrough mode by checking the light on the Management card.

If this is not the case and you are inserting a Clock card that does not have the most recent configuration for that specific shelf, you must reprogram the new Clock card in another shelf to match the desired shelf configuration. Failure to do so will change the configuration to the one stored in the new card. This may affect the output signals.

To replace the Clock card, follow the procedure below, and refer to [Figure 5-4](#).

1. Put on a properly grounded ESD wrist strap.
2. Press the Force Active button on the *other* Clock card to ensure that the card you're replacing is in Standby.
3. Using a #2 Phillips-head or Pozidrive screwdriver, loosen the captive screws on the front panel.
4. Remove the card from the shelf.
5. Set switch S1 on the replacement card to match the original card.
6. Insert the replacement card into the shelf: ensure that the card aligns properly with its mating backplane connector; push the card into place until it is fully seated into the backplane connectors.
7. Wait for the Warmup LED to turn off on the replacement card (approximately 2 minutes to 20 minutes) and the Tracking LED to light.
8. Press the Cutoff pushbutton on the Management card several times.
9. Verify that any alarm conditions are cleared.
10. Tighten the captive screws at the top and bottom of the card.

Replacing the Output Driver Card

To replace the Output Driver card, follow the procedure below while referring to [Figure 5-6](#).

1. Put on a properly grounded ESD wrist strap.
2. Using a #2 Phillips-head or Pozidrive screwdriver, loosen the captive screws on the front panel.
3. Remove the card from the shelf.
4. Insert the replacement card into the shelf: ensure that the card aligns properly with its mating backplane connector; push the card into place until it is fully seated into the backplane connectors.
5. Wait for the Power LED to light, the DS1 and/or CC LEDs to light according to the Output Connector cards installed, and the Fail and Alarm LEDs to turn off.
6. Press the Cutoff pushbutton on the Management card several times.
7. Verify that any alarm conditions are cleared.
8. Tighten the captive screws at the top and bottom of the card.

Replacing the Management Card

To replace the Management card, follow the procedure below while referring to [Figure 5-7](#).

1. If applicable, remove the cable connected to the Management card.
2. Put on a properly grounded ESD wrist strap.
3. Using a #2 Phillips-head or Pozidrive screwdriver, loosen the captive screws on the front panel of the card.
4. Remove the card from the shelf.
5. Set switch S1 on the replacement card to match the original card.
6. Insert the replacement card into the shelf: ensure that the card aligns properly with its mating backplane connector; push the card into place until it is fully seated into the backplane connectors.
7. Verify that the Power LED is lit.

8. If using a LAN connection, connect a nine-pin male-to-female RS-232 interface cable from the communication port on a computer with communications software to the Local port on the TimeHub 5500. If not, skip to Step 13.
9. Configure the network parameters (see [Communicating by Ethernet](#), on page 116, for details).
10. Wait approximately 2 minutes.
11. Press the Cutoff pushbutton several times.
12. Verify that any alarm conditions are cleared.
13. If applicable, re-connect the cable that was connected to the Management card.
14. If using a local communication connection, verify that the Local LED is lit. If using an LAN connection, verify that the Link LED is lit.
15. Tighten the captive screws at the top and bottom of the card.

Replacing the Expansion Controller Card

To replace the Expansion Controller card, follow the procedure below, and refer to [Figure 5-8](#).

1. Put on a properly grounded ESD wrist strap.
2. Using a #2 Phillips-head or Pozidrive screwdriver, loosen the captive screws on the front panel.
3. Remove the card from the shelf.
4. Insert the replacement card into the shelf: ensure that the card aligns properly with its mating backplane connector; push the card into place until it is fully seated into the backplane connectors.
5. Wait for the Power LED to light, the Shelf Power and Expansion Links LEDs to light, and the Fail and Alarm LEDs to turn off.
6. Press the Cutoff pushbutton on the Management card several times.
7. Verify that any alarm conditions are cleared.
8. Tighten the captive screws at the top and bottom of the card.

Replacing Fuses

Replacing the Fuse in the Clock Card

To replace the fuse on the Clock card, follow the steps in this section. [Figure 5-9](#) shows the location of the fuse holder.

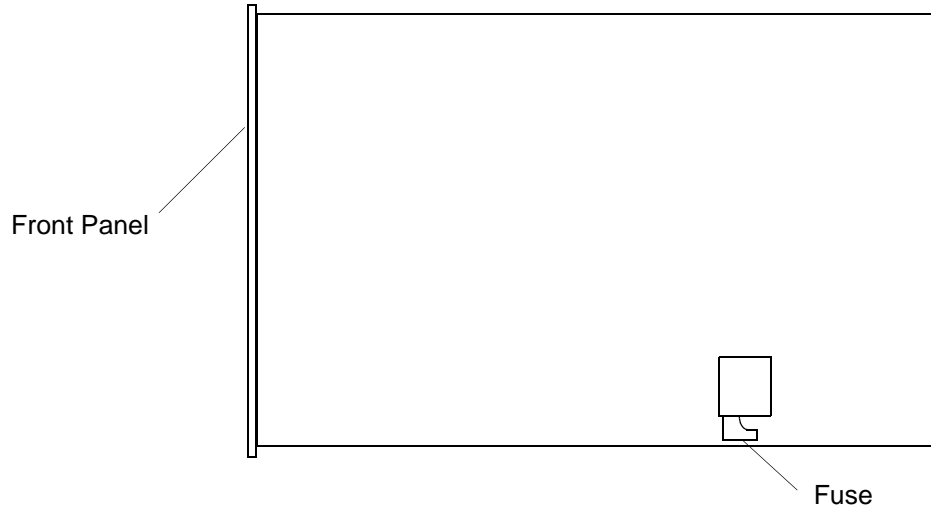

Figure 5-9. Location of Fuse XF1 on the Clock Card

1. Put on a properly grounded ESD wrist strap.
2. Press the Force Active button on the *other* Clock card to ensure that the card you're replacing is in Standby.
3. Using a #2 Phillips-head or Pozidrive screwdriver, loosen the captive screws on the front panel.
4. Remove the card from the shelf.
5. Using a GMT fuse puller, remove the fuse from the fuse holder labeled XF1.
6. Replace the fuse with a 3-A GMT fuse. Do not force the fuse when inserting it; the fuse should easily snap-fit into the holder.
7. Insert the card into the shelf: ensure that the card aligns properly with its mating backplane connector; push the card into place until it is fully seated into the backplane connectors.
8. Wait for the Warmup LED to turn off on the card (approximately 2 minutes to 20 minutes) and the Tracking LED to light.

9. Press the Cutoff pushbutton on the Management card several times.
10. Verify that any alarm conditions are cleared.
11. Tighten the captive screws at the top and bottom of the card.

Replacing the Fuse in the Management Card

To replace the fuse on the Management card, follow the procedure in this section. [Figure 5-10](#) shows the location of the fuse holder on the card.

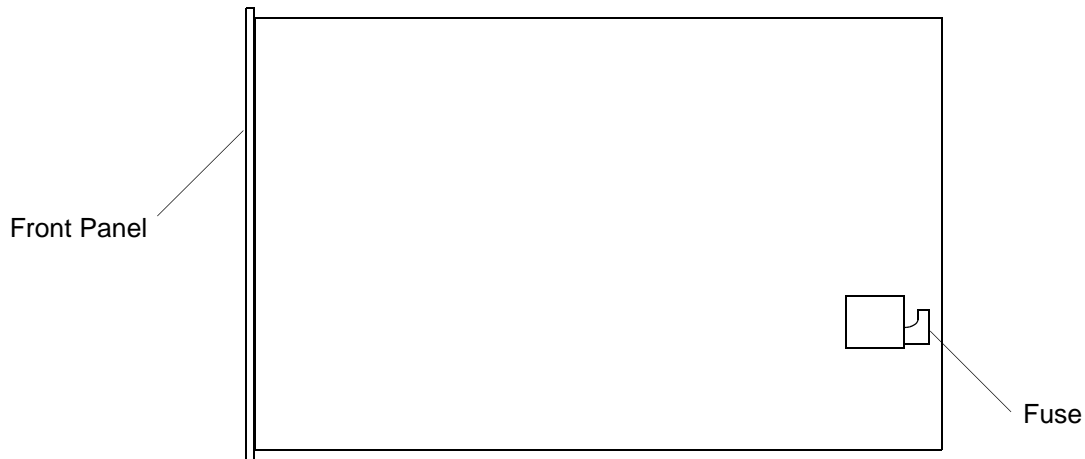

Figure 5-10. Location of Fuse F1 on the Management Card and the Output Driver Card

1. Put on a properly grounded ESD wrist strap.
2. If applicable, remove the cable connected to the Management card.
3. Using a #2 Phillips-head or Pozidrive screwdriver, loosen the captive screws on the front panel of the card.
4. Remove the card from the shelf.
5. Using a GMT fuse puller, remove the fuse from the fuse holder labeled F1.
6. Replace the fuse with a 1-A GMT fuse. Do not force the fuse when inserting it; the fuse should easily snap-fit into the holder.
7. Insert the card into the shelf: ensure that the card aligns properly with its mating backplane connector; push the card into place until it is fully seated into the backplane connectors.
8. Verify that the Power LED is lit.

9. Press the Cutoff pushbutton several times.
10. Verify that any alarm conditions are cleared.
11. If applicable, re-connect the cable that was connected to the card.
12. If using a local communication connection, verify that the Local LED is lit. If you are using a LAN connection, verify that the Link LED is lit.
13. Tighten the captive screws at the top and bottom of the card.

Replacing the Fuse in the Output Driver Card

To replace the fuse on the Output Driver card, follow the procedure in this section. [Figure 5-10](#) shows the location of the fuse holder on the card.

1. Put on a properly grounded ESD wrist strap.
2. Using a #2 Phillips-head or Pozidrive screwdriver, loosen the captive screws on the front panel of the card.
3. Remove the card from the shelf.
4. Using a GMT fuse puller, remove the fuse from the fuse holder labeled F1.
5. Replace the fuse with a 1-A GMT fuse. Do not force the fuse when inserting it; the fuse should easily snap-fit into the holder.
6. Insert the card into the shelf: ensure that the card aligns properly with its mating backplane connector; push the card into place until it is fully seated into the backplane connectors.
7. Wait for the Power LED to light, the DS1 and/or CC LEDs to light according to the output connector cards installed, and the Fail and Alarm LEDs to turn off.
8. Press the Cutoff pushbutton on the Management card several times.
9. Verify that any alarm conditions are cleared.
10. Tighten the captive screws at the top and bottom of the card.

Replacing the Fuse in the EC Card

To replace the fuse on the EC card, follow the procedure in this section. [Figure 5-11](#) shows the location of the fuse holder on the card.

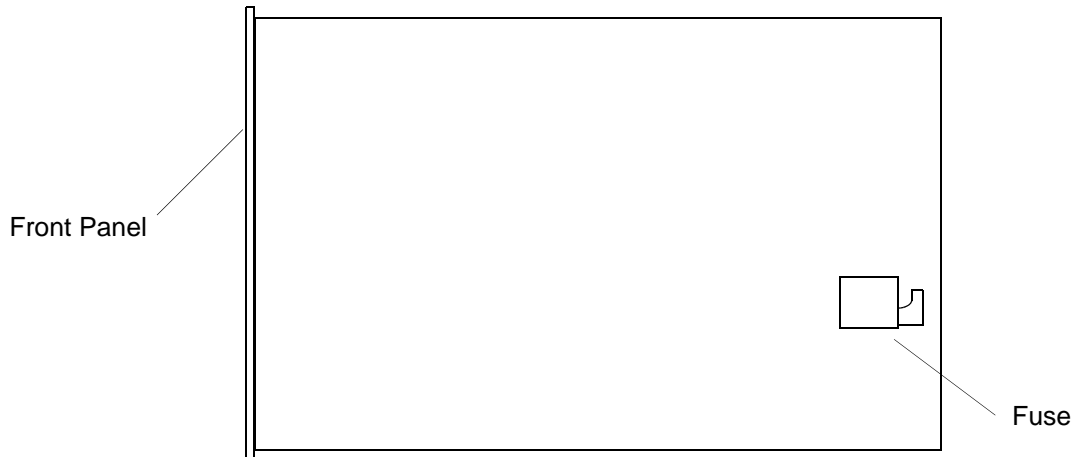

Figure 5-11. Location of Fuse F1 on the EC Card

1. Put on a properly grounded ESD wrist strap.
2. Using a #2 Phillips-head or Pozidrive screwdriver, loosen the captive screws on the front panel of the card.
3. Remove the card from the shelf.
4. Using a GMT fuse puller, remove the fuse from the fuse holder labeled F1.
5. Replace the fuse with a 1-A GMT fuse. Do not force the fuse when inserting it; the fuse should easily snap-fit into the holder.
6. Insert the card into the shelf: ensure that the card aligns properly with its mating backplane connector; push the card into place until it is fully seated into the backplane connectors.
7. Wait for the Power LED to light, the Shelf Power and Expansion Links LEDs to light, and the Fail and Alarm LEDs to turn off.
8. Press the Cutoff pushbutton on the Management card several times.
9. Verify that any alarm conditions are cleared.
10. Tighten the captive screws at the top and bottom of the card.

Upgrading the Software

From time to time, Symmetricom releases software to improve the performance of the TimeHub 5500. This section describes how to install a software upgrade to the unit. You will need to have a computer that is connected to the TimeHub via the serial or Ethernet port

You perform the software upgrade using an existing serial or Ethernet connection. See [Establishing a Connection to the TimeHub](#), on page 113, for instructions on establishing communication with the TimeHub.

Use the following procedure to connect to the TimeHub using the TimeHub WARP software. The TimeHub WARP Download Utility is available on the user documentation CD provided with the Management Card kit, and is also available on the Symmetricom support web page (www.symmetricom.com).



Note: To ensure that upgrades are successful for all TimeHub configurations, use TimeHub WARP version 2.0. Select About from the Help menu to display the version. TimeHub WARP version 2.0 is available on CD (part number 692-55500-10 Rev N); the CD also contains a PDF version of the user documentation set.

1. Ensure that the TimeHub is connected to a LAN. See [Making Communication Connections](#), on page 88 for details.
2. Start the TimeHub WARP application. The application window appears, as shown in [Figure 5-12](#).
3. Enter the IP address and port number in the appropriate fields.
4. Enter a Security-level user name and password in the appropriate fields. If a Security-level user is not entered into the user list, refer to [Managing the User List](#), on page 153 for more details.
5. Click **Rtrv Info**. The current information for the TimeHub appears in a log window, as shown in [Figure 5-13](#). If an error dialog box appears, verify that the entries in the top four fields are valid.
6. Click **Hide Log**, if desired, to close the Log window. This button toggles to Show Log when the log window is closed.
7. Select the target device for the new software in the Download to: combo box. You can leave this set to All Cards, as the TimeHub WARP application does not update current software versions.

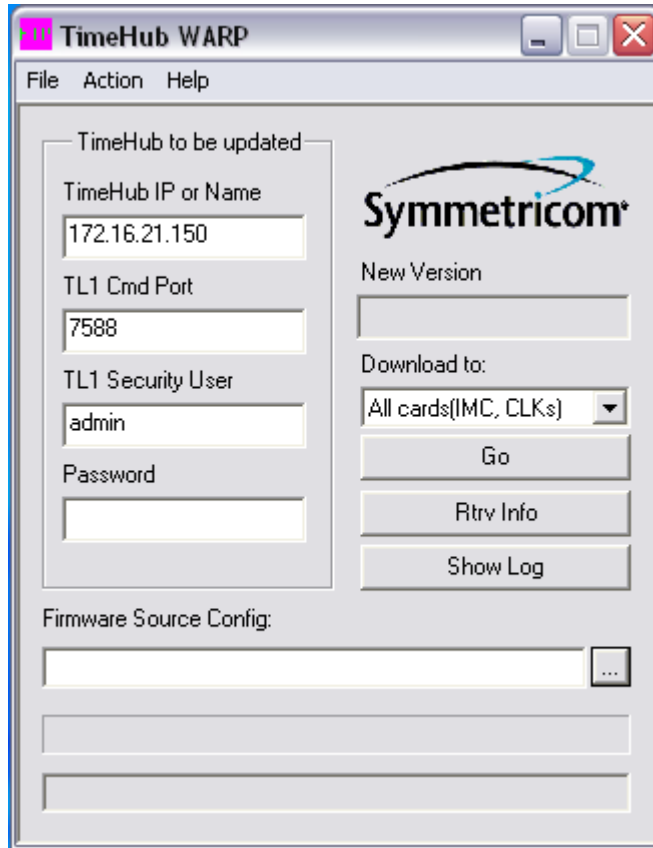

Figure 5-12. The TimeHub WARP Window

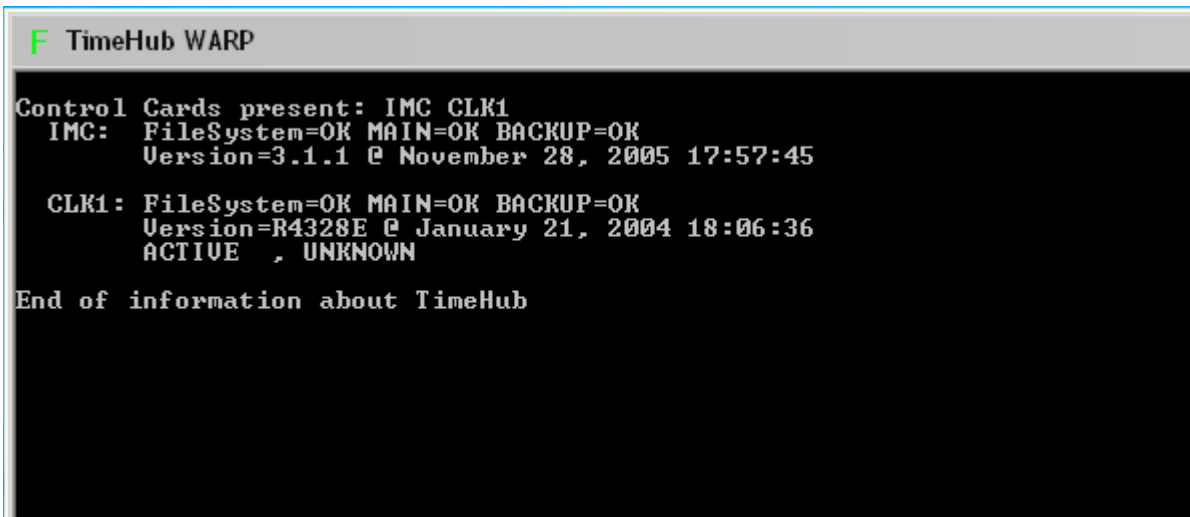

Figure 5-13. The WARP Log Window

8. Click ... to navigate to the desired source .CFG file. The selected file appears in the New Version field.

9. Click **Go** to start the download.



Warning: To avoid corrupting the file system, do not power down the shelf or remove cards while the software is downloading.

If a warning box appears indicating that the file system on Clock 1 or Clock 2 is corrupt, click **Abort** and skip to [Manually Downloading Software](#), on page 194.

10. Click **OK** to complete the download when the Success dialog box appears.

Manually Downloading Software

You can download software to the TimeHub using DOS and TL1 commands if you do not have the TimeHub WARP application. You can also use this procedure if TimeHub WARP indicates that the file system on the Clock 1 or Clock 2 card is corrupt.

You need to have a computer connected to the serial or Ethernet port on the TimeHub, and a copy of the software that you want to install on the TimeHub.

1. Open a command window by selecting **Start, Run** (or other method, depending on the operating system in the computer). The Run window appears, as shown in [Figure 5-14](#).

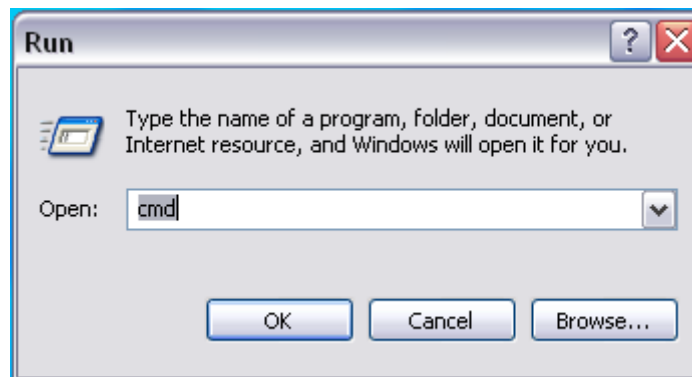
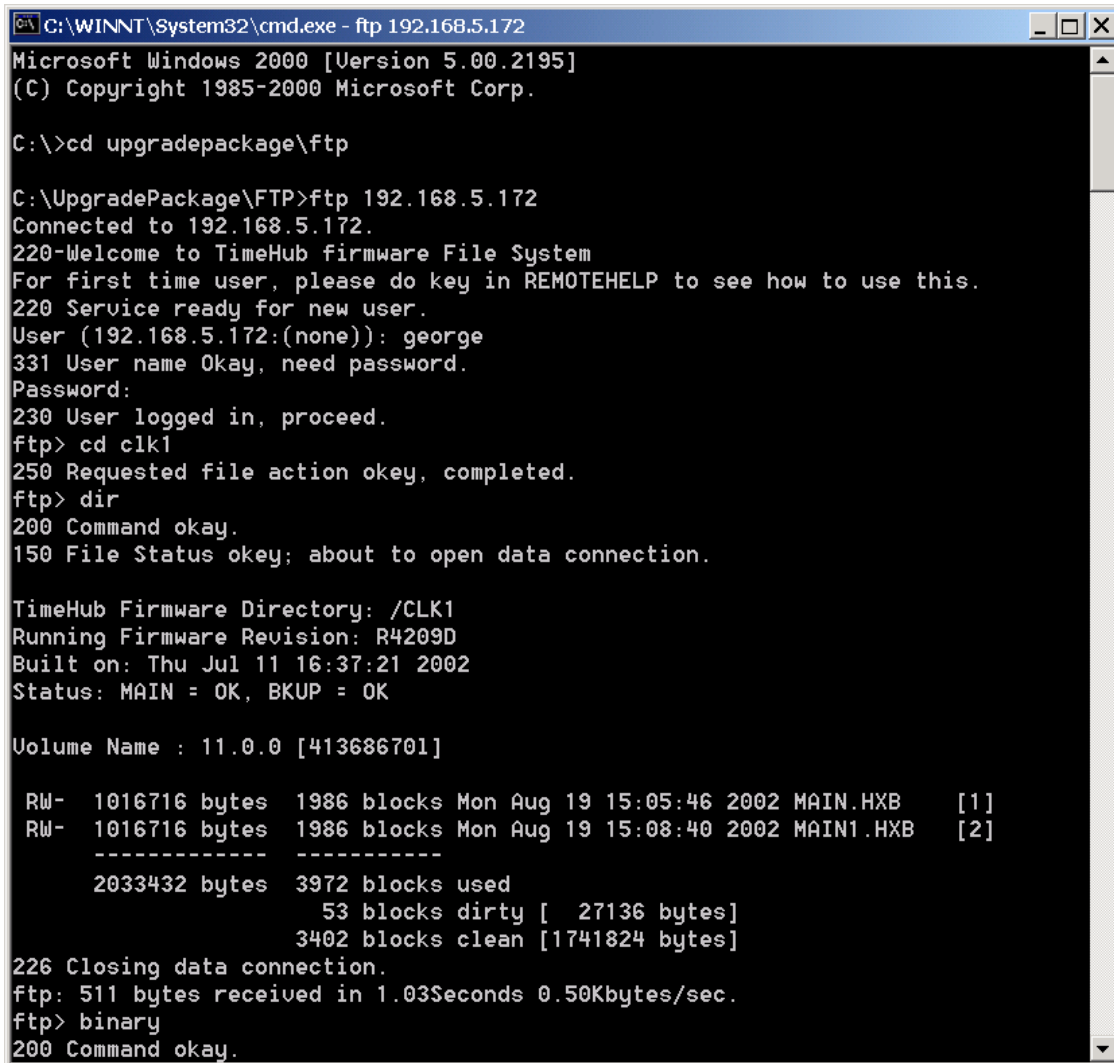

Figure 5-14. The Windows Run Dialog Box

2. Type `cmd` and click **OK** to open the command window.
3. Type `cd upgradepackage\ftp` (or other appropriate path name) and press **Enter** to set the command window to the FTP directory containing the files that you want to download to the TimeHub.

Connecting to the TimeHub

4. Type `ftp <ip address>` and press **Enter** to connect to the TimeHub, where `<ip address>` is the address of the TimeHub. In the example shown in [Figure 5-15](#), the address is 192.168.5.172. The TimeHub requests a user name.



```
C:\WINNT\System32\cmd.exe - ftp 192.168.5.172
Microsoft Windows 2000 [Version 5.00.2195]
(C) Copyright 1985-2000 Microsoft Corp.

C:\>cd upgradepackage\ftp

C:\UpgradePackage\FTP>ftp 192.168.5.172
Connected to 192.168.5.172.
220-Welcome to TimeHub firmware File System
For first time user, please do key in REMOTEHELP to see how to use this.
220 Service ready for new user.
User (192.168.5.172:(none)): george
331 User name Okay, need password.
Password:
230 User logged in, proceed.
ftp> cd clk1
250 Requested file action okay, completed.
ftp> dir
200 Command okay.
150 File Status okay; about to open data connection.

TimeHub Firmware Directory: /CLK1
Running Firmware Revision: R4209D
Built on: Thu Jul 11 16:37:21 2002
Status: MAIN = OK, BKUP = OK

Volume Name : 11.0.0 [413686701]

RW- 1016716 bytes 1986 blocks Mon Aug 19 15:05:46 2002 MAIN.HXB [1]
RW- 1016716 bytes 1986 blocks Mon Aug 19 15:08:40 2002 MAIN1.HXB [2]
-----
2033432 bytes 3972 blocks used
53 blocks dirty [ 27136 bytes]
3402 blocks clean [1741824 bytes]
226 Closing data connection.
ftp: 511 bytes received in 1.03Seconds 0.50Kbytes/sec.
ftp> binary
200 Command okay.
```

Figure 5-15. Example FTP Download Process, Part 1

5. Type a valid Security-level user name and press **Enter**. The TimeHub requests a password.
6. Type the password for the user and press **Enter**. The TimeHub responds with `230 User logged in, proceed`. If you do not succeed in logging in, check that you correctly entered the user name and password, and ensure that the user name is at the Security level. To create a new user, see [Managing the User List](#), on page 153.

Selecting the Target Card

7. Type `cd` and one of the following to select the card that will have its firmware upgraded:

- `IMC` for the IMC card
- `CLK1` for the Clock card in Slot 1
- `CLK2` for the Clock card in Slot 2

then press **Enter**. If you are upgrading a Clock card, select the directory for the Standby clock. You can determine which Clock card is in Standby by looking at the front panel Active/Standby LED or by issuing the `RTRV-COND TL1` command.

8. Type `dir` and press **Enter** to view the files in the directory; a sample is shown in [Figure 5-15](#). Check that the card is running the expected firmware version.

Verify that the files are not corrupted by adding together the number of “used”, “dirty” and “clean” blocks. Use the following table to determine the action based on the sum. .

Sum of Blocks	Indication	Firmware Compatibility
7427	Original CPU memory	Compatible with all firmware versions.
15521	New CPU memory	Compatible with firmware version 3.2.1 or newer. Note: If you are downloading a version older than 3.2.1, STOP! The new CPU memory does not support it. Use version 3.2.1.
Any other value	File system is corrupt. Skip to Repairing a Corrupt File System , on page 200	

The only files in the directory should be `MAIN.HXB` and `MAIN1.HXB`. Typically there are no other files in the directory.

9. Type `del <filename>` then press **Enter** to delete all files other than `MAIN.HXB` and `MAIN1.HXB`.

Preparing to Transfer Files

10. Type `binary`, then press **Enter** to set the binary transfer mode.

11. Type `type`, then press **Enter** to confirm the binary transfer mode is selected. See [Figure 5-16](#) for a continuation of the example.

```
C:\WINNT\System32\cmd.exe - ftp 192.168.5.172
ftp> type
Using binary mode to transfer files.
ftp> cd clk1
550 Requested action not taken.
ftp> quote boot
200 Command okay.
ftp> cd ..
250 Requested file action okey, completed.
ftp> cd clk2
250 Requested file action okey, completed.
ftp> dir
200 Command okay.
150 File Status okay; about to open data connection.

TimeHub Firmware Directory: /CLK2
Running Firmware Revision: R4209D
Built on: Thu Jul 11 16:37:21 2002
Status: MAIN = OK, BKUP = OK

Volume Name : 11.0.0 [413753261]

RW- 1016716 bytes 1986 blocks Mon Jul 22 14:38:02 2002 MAIN.HXB [1]
RW- 1016716 bytes 1986 blocks Mon Jul 22 14:40:54 2002 MAIN1.HXB [2]
-----
2033432 bytes 3972 blocks used
1 block dirty [ 512 bytes]
3454 blocks clean [1768448 bytes]
226 Closing data connection.
ftp: 511 bytes received in 0.99Seconds 0.52Kbytes/sec.
ftp> put clock/main.hxb
200 Command okay.
150 File Status okay; about to open data connection.
226 Closing data connection.
ftp: 1016909 bytes sent in 132.70Seconds 7.66Kbytes/sec.
```

Figure 5-16. Example FTP Download Process, Part 2

12. Type `put clock main.hxb`, then press **Enter** to start the file transfer.

If you did not change to the directory containing the MAIN.HXB file in Step 3, this command will fail. Use the `cd` command to ensure that you are in the appropriate directory.

The transfer time is typically 2 minutes, and ends with a message indicating the number of bytes sent, the time it took to send the file, and the transfer rate.



Warning: To avoid corrupting the file system, do not power down the shelf or remove cards while the software is downloading.

Confirming the File Transfer

13. Type `dir`, then press **Enter** to confirm that the file MAIN.HXB is present with a newer date and time and the MAIN1.HXB file is unchanged. Figure 5-17 shows the continuation of the example.

```
C:\WINNT\System32\cmd.exe - ftp 192.168.5.172
ftp> dir
200 Command okay.
150 File Status okay; about to open data connection.

TimeHub Firmware Directory: /CLK2
Running Firmware Revision: R4209D
Built on: Thu Jul 11 16:37:21 2002
Status: MAIN = OK, BKUP = OK

Volume Name : 11.0.0 [11]

RW- 1016909 bytes 1987 blocks Thu Sep 19 16:40:44 2002 MAIN.HXB [1]
RW- 1016716 bytes 1986 blocks Mon Jul 22 14:40:54 2002 MAIN1.HXB [2]
-----
      2033625 bytes 3973 blocks used
              2094 blocks dirty [1072128 bytes]
              1360 blocks clean [ 696320 bytes]
226 Closing data connection.
ftp: 504 bytes received in 12.99Seconds 0.04Kbytes/sec.
ftp> quote boot
200 Command okay.
ftp> cd ..
250 Requested file action okay, completed.
ftp> dir
200 Command okay.
150 File Status okay; about to open data connection.

TimeHub Firmware Directory: /

DRWX----- IMC      [mapped to IMC card  ]
DRWX----- CLK1    [mapped to Clock card 1]
DRWX----- CLK2    [mapped to Clock card 2]

226 Closing data connection.
ftp: 173 bytes received in 0.03Seconds 5.77Kbytes/sec.
ftp> cd IMC
250 Requested file action okay, completed.
```

Figure 5-17. Example FTP Download Process, Part 3

Restarting the Clock Card

14. Type `dir`, then press **Enter** to ensure that you are in the intended directory; in this case, it should be the `/CLK1` directory. If you are not in the intended directory, type `cd clk1`, then press **Enter**.

15. Type `quote boot`, then press **Enter** to restart the Clock card in slot 1.

Observe the front panel LEDs and wait for the Clock card to come out of warmup and resume normal operation. This usually includes the time required to track the inputs. If you are performing this procedure remotely, use TimeScan THC to observe the status, or issue the `RTRV-COND` and `RTRV-NETTYPE-ALL` commands.

16. Press the Force Active button on the Clock card you just upgraded to make it the Active clock, or use the `SW-DX-EQPT` command from a remote location.

Downloading to the Second Clock Card

17. Download software to the second clock card using steps 7 through 16. [Table 5-5](#) summarizes the steps.

Table 5-5. Downloading to the Second Clock Card

Type This:	Comment
<code>cd ..</code>	Change back to the root directory.
<code>cd c12</code>	Change to the Clock 2 directory.
<code>dir</code>	Check the file system for the Clock 2 directory.
<code>put clock/main.hxb</code>	Download the file to Clock 2.
<code>dir</code>	Check that the download is OK.
<code>quote boot</code>	Restart Clock 2.

Downloading to the IMC Card

18. Download software to the IMC card using steps 7 through 16. [Table 5-6](#) summarizes the steps.

Table 5-6. Downloading to the IMC Card

Type This:	Comment
<code>cd ..</code>	Change back to the root directory.
<code>cd IMC</code>	Change to the IMC directory.
<code>dir</code>	Check the file system for the IMC directory.
<code>put imc/main.hxb</code>	Download the file to the IMC.
<code>dir</code>	Check that the download is OK.
<code>quote boot</code>	Restart the IMC. The ftp session ends; the IMC should return to normal operation within a minute.

Backing Up the New Software

Once you install the software and the TimeHub is operating normally, Symmetricom recommends that you back it up. After performing the procedure in the previous section, each card contains a copy of the new version of MAIN.HXB and, most likely, a copy of the version it was running prior to the upgrade in MAIN1.HXB. If MAIN.HXB becomes corrupt, then the TimeHub automatically runs MAIN1.HXB.

This procedure copies the MAIN.HXB file into the MAIN1.HXB file. All cards operate normally during this procedure. [Table 5-7](#) summarizes the steps.

Table 5-7. Downloading to the Second Clock Card

Type This:	Comment
<code>ftp <ip address></code>	Log in to the TimeHub.
<code>dir</code>	View the root directory file system.
<code>cd imc</code>	Go to the IMC directory.
<code>quote backup</code>	Create a backup copy of MAIN.HXB in the IMC directory. This takes approximately 3 minutes. You cannot make changes to the file system during this time.
<code>cd..</code>	Return to the root directory.
<code>cd clk1</code>	Go to the CLK1 directory.
<code>quote backup</code>	Create a backup copy of MAIN.HXB in the CLK1 directory. This takes approximately 3 minutes. You cannot make changes to the file system during this time.
<code>cd..</code>	Return to the root directory.
<code>cd clk2</code>	Go to the CLK2 directory.
<code>quote backup</code>	Create a backup copy of MAIN.HXB in the CLK2 directory. This takes approximately 3 minutes. You cannot make changes to the file system during this time.
<code>quit</code>	Exit the ftp session.

Repairing a Corrupt File System

If the number of blocks used in any of the TimeHub's directory structures does not total 7427 (old CPU memory) or 15521 (new CPU memory), then the file system in that directory is corrupt.

To repair a corrupt file system:

1. Connect to the TimeHub as shown in [Connecting to the TimeHub](#), on page 195.
2. Type `cd` and one of the following to select the directory that is corrupt:
 - `IMC` for the IMC card
 - `CLK1` for the Clock card in Slot 1
 - `CLK2` for the Clock card in Slot 2

then press **Enter**.

3. Type `dir`, then press **Enter** to display the directory structure.
4. Add the values next to the used, dirty, and clean blocks, and verify that the total is neither 7427 nor 15521. If the total is 7427 (old CPU memory) or 15521 (new CPU memory), then the file system is not corrupt.
5. Type `quote format.timehub.2001`, then press **Enter** to format the file system. The card associated with the selected directory remains fully operational.



Warning: To avoid disabling the card whose directory is being formatted, do not remove the card from the shelf or remove power from the shelf during this process.

6. Type `quote format.timehub.2001`, then press **Enter** to format the file system again.
7. Type `dir`, then press **Enter** to view the directory structure.
8. Add the values next to the used, dirty, and clean blocks, and verify that the total is now 7427 (old CPU memory) or 15521 (new CPU memory).

Returning the TimeHub for Repair

You should return the equipment to Symmetricom only after you have exhausted the troubleshooting procedures described earlier in this chapter, or if Symmetricom Global Services has advised you to return the unit.



Note: Please retain the original packaging for re-shipping the product. If the original packaging is not available, contact Symmetricom Global Services (SGS) for assistance.

Repacking the Unit

Return all units in the original packaging. If the original packaging is not available, contact Symmetricom Global Services. Use standard packing procedures for products being returned for repair to protect the equipment during shipment. Connectors should be protected with connector covers or the equipment should be wrapped in plastic before packaging.

Equipment Return Procedure

To return equipment to Symmetricom for repair:

1. Call Symmetricom Global Services (SGS) at 888-367-7966 (toll-free in USA only), 408-428-7907, or +49 700 3288 6435 in Europe, Middle East, or Africa to obtain a return material authorization number (RMA) before returning the product for service.

You can request an RMA on the internet at
https://www.symmetricom.com/Support/req_repair.htm.

Retain the assigned RMA number for future reference.

2. Provide a description of the problem, product item number, serial number, and warranty expiration date.
3. Provide the return shipping information (customer field contact, address, telephone number, and so forth.)
4. Ship the product to Symmetricom, transportation prepaid and insured, with the Return Material Authorization (RMA) number and item numbers or part numbers clearly marked on the outside of the container to the address given with the RMA.

Repaired equipment is returned to you with shipping costs prepaid by Symmetricom.

Contacting Symmetricom Global Services

If you encounter any difficulty installing or operating the product, contact Symmetricom Global Services at:

U.S.A. Call Center:

Symmetricom, Inc.
2300 Orchard Parkway
San Jose, CA 95131-1017

Toll-free North America: 888-367-7966
Tel: 408-428-7907
Fax: 408-428-7998

E-mail: support@symmetricom.com
Internet: <http://www.symmetricom.com>

Europe, Middle East, and Africa (EMEA) Call Center:

Symmetricom Global Services EMEA
Fichtenstr. 25
85649 Hofolding Germany

Tel: +49 700 3288 6435

Fax: +49 8104 662 433

E-mail: emeasupport@symmetricom.com

Internet: <http://www.symmetricom.com>

User Manual Updates

From time to time, this manual may be updated. The updated version of the manual will be available for downloading in electronic form via the Internet. After downloading, the manual can be viewed on a computer or printed out.

Manual updates are available at:

<http://www.symmetricom.com/support/login/login.php>



Note: If you are downloading a manual for the first time, you will need to register with Symmetricom. If you are currently registered, login and download the manual update.

Chapter 6 Specifications

This chapter includes:

- [Overview](#)
- [Factory Default Values](#)

Overview

The TimeHub 5500 equipment specifications are listed as follows.

Local Communication Port

Connector Type: 9-pin, female D connector

Connector Label: Local

Connector Location: Management card (front)
Rear of shelf

Electrical Interface: RS-232

Baud Rate: 1200 bps
2400 bps
9600 bps (default)
19.2 kbps

Data Bits: 8

Parity Bit: None

Stop Bits: 1

Flow Control: None

LAN Communication Port

Connector Type: RJ-45 (10 Base-T)

Connector Label: LAN

Connector Location: Rear of shelf

Remote Communication Port

Reserved for future use.

GPS Input

Reserved for future use.

Expansion Link 1 Input

Connects to an optional Expansion shelf.

Expansion Link 2 Input

Connects to an optional Expansion shelf.

DS1 Inputs

Connector Type: Wire-wrap pins

Connector Label: DS1 REF (T, R, S)

DS1 MON (T, R, S)

Connector Location: Input/Alarm Connector card (rear of shelf)

Number of Inputs: 4 reference inputs and/or monitoring
4 additional inputs for monitoring only
(Clocks 090-55512-02 or 090-55514-02 required)

Bit Rate: 1.544 Mb/s

Impedance: 100 Ω

Format: DS1 (Telcordia GR-499-CORE; ANSI T1.101)

Framing: D4
ESF

Line Code: B8ZS

SSM State: Enable

Disable

Cable Attenuation: 7.0 dB maximum

LOS Threshold: -14 dB to -10 dB (terminated) relative to
nominal 3 V amplitude

-34 dB to -30 dB (bridged) relative to
nominal 3 V amplitude

PRS Reference Input

Connector Type: BNC

Connector Label: 5/10 MHz IN

Connector Location: Input/Alarm Connector card (rear of shelf)

Number of Inputs: 1

Frequency: 5 MHz or 10 MHz

Impedance: 50 Ω

Format: Sine or square wave

Amplitude: 0.5 V p-p

Composite Clock Inputs

Connector Type: Wire-wrap pins

Connector Label: CC IN 1 (T, R, S)
CC IN 2 (T, R, S)

Connector Location: Input/Alarm Connector card (rear of shelf)

Number of Inputs: 2

Bit Rate: 64 kb/s

Impedance: 133 Ω

Format: Bipolar RTZ

DS1 Outputs

Connector Type: Wire-wrap pins

Connector Label: 1–20 (S, T, R)

Connector Location: Wire-wrap panel

Number of Outputs: Up to 40 protected or non-protected outputs per card

Maximum of 140 per master shelf. Additional capacity available using Expansion shelves

Bit Rate:	1.544 Mb/s
Impedance:	100 Ω balanced
Format:	DS1
Framing:	D4 ESF
SSM:	Enable Disable
Line Code:	B8ZS
Amplitude:	2.4 V to 3.6 V terminated with 100 w

Composite Clock Outputs

Connector Type:	Wire-wrap pins
Connector Label:	1–20 (S, T, R)
Connector Location:	Wire-wrap panel
Number of Outputs:	Up to 40 protected or non-protected outputs per card Maximum of 140 per master shelf. Additional capacity available using Expansion shelves
Bit Rate:	64 kb/s
Impedance:	133 Ω balanced
Line Code:	Bipolar RTZ

Output Alarms

Connector Type:	Wire-wrap pins
Connector Label:	OFFICE ALARMS (NC, C, NO)
Connector Location:	Input/Alarm Connector card (rear)
Contact Type:	Dry contact
Severity:	Critical (audible and visible) Major (audible and visible) Minor (audible and visible)
State:	Normally open and normally closed

Input Alarms

Connector Type:	Wire-wrap pins
Connector Label:	EXT ALARM INPUTS (+, -)
Connector Location:	Input/Alarm Connector card (rear)
Number of Inputs:	10 (4 universal, 6 contact closure only)
Contact Type:	Relay closure monitoring
Severity:	Fixed
State:	Normally open

Power

Connector Type:	Terminal block
Connector Labels:	Return/-48V (A) Return/-48V (B)
Connector Location:	Rear panel
Voltage:	-42 V dc to -60 V dc (each connector)
Current:	Master/Remote Shelf: 180 W Expansion Shelf: 100 W
Recommended Battery Feed Fuse:	10 A

Shelf Mechanical

Mounting:	NEBS 19 in. rack NEBS 23 in. rack
Rack Mounting Position:	Flush Offset: 2 in (5 cm) or 5 in. 12.7 cm)
Width:	16.6 in. (42.2 cm)
Height:	10.5 in. (26.7 cm)
Depth:	11.6 in. (29.5 cm)
Weight:	14 lb (6.4 kg) empty 40 lb (18.2 kg) fully loaded

Wire-wrap Panel Mechanical

Mounting:	19 in. rack or 23 in. rack (with supplied mounting ears)
Rack Mounting Position:	Flush 5 in. (12.7 cm) offset
Width:	16.6 in. (42.2 cm)
Height:	5.25 in. (13.3 cm): wire-wrap module type 3.5 in. 8.9 cm): built-in wire-wrap pin type
Depth:	4.6 in. (11.7 cm)

Shelf and Wire-wrap Panel Environmental

Operating Temperature:	0 °C to +45 °C
Operating Humidity:	5% to 95%
Electromagnetic Compliance:	FCC Part 15, Sub Part B, Class A

Certification

NEBS Level 3 compliant

Factory Default Values

This section describes the factory default values for parameters within the TimeHub 5500.

Management Card Default Settings

[Table 6-1](#) lists the factory defaults for the Management card in the TimeHub 5500.

Table 6-1. Management Card Default Settings

Setting	Factory Default	Range
Security	Off	On (Enabled) / Off (Disabled)
Unit Name	TimeHub	–
User List configurations	Maximum of 25 users	–

Table 6-1. Management Card Default Settings (Continued)

Setting	Factory Default	Range
EIA-232-C Port	9600 baud No parity 8 data bits, 1 stop bit Y Handshaking disabled	1200 / 2400 / 9600 / 19200 – – Y (Echo On) / N (Echo Off) –
Ethernet IP Address	IP Address 0.0.0.1 Gateway Address 0.0.0.1 Network Mask 255.255.248.0	– – –
Inactivity Time	100 sec	0 to 10 000 sec
RPTALL	Firmware version 3.2: Y Firmware prior to 3.2: N	Y N

Clock Card Default Settings

Table 6-2 lists the factory defaults for the TimeHub 5500 Clock card.

Table 6-2. Clock Card Default Settings

Setting	Factory Default	Range
Bridged Mode	N	Y / N
CC Delay	0 ns	–10 000 to 10 000 ns
Freerun Action	<ul style="list-style-type: none"> ■ Continue (Master) ■ Squelch (Remote) 	Continue / Squelch
Holdover and Freerun Quality Level	<ul style="list-style-type: none"> ■ 3 (Primary) ■ 5 (Secondary) 	1 to 9
Input Enable	<ul style="list-style-type: none"> ■ Y (1 to 4) ■ N (5 to 8) 	Y / N
Input Framing	Y	Y (ESF) / N (D4)
Input Priority	<ul style="list-style-type: none"> ■ Input no. +1 (prior to firmware version 4263B) ■ PRS: 1 Others: 2 Remote: 2 (firmware version 4263B and later) 	0 to 9
Input Selection Mode	Auto	Auto / Manual / Forced
Main Clock	Y	Y (Master) / N (Remote)

Table 6-2. Clock Card Default Settings (Continued)

Setting	Factory Default	Range
Measurement Delay	0 sec	0 to 1800 sec
Output Connector Card type	Don't Care	Don't Care / DS1 / CC
PRC Frequency	N	Y (5 MHz) / N (10 MHz)
Pull-in Range	<ul style="list-style-type: none"> ■ 16 (Primary Oscillator) ■ 4600 (Secondary Oscillator) 	10 to 10 000 ppb
Quality Cutoff (Read Input SSM enabled)	3	1 to 9
Quality Level (Read Input SSM disabled)	<ul style="list-style-type: none"> ■ 1 (PRS) ■ 2 (Inputs 1 –4) 	1 to 9
Read Input SSM Bits	N	Y / N
Sync Mode	Auto	<ul style="list-style-type: none"> ■ Auto / Manual / Force (prior to firmware version 4263B) ■ Auto / SSM (firmware version 4263B and later)
Time Constant (primary clock)	768	192 / 768 / 3072 / 12288 / 49152
Time Constant (secondary clock)	384	102 / 190 / 384 / 1824 / 24864
Wait Time to restore Sync source	30 sec	0 to 1000 sec

Output Driver Card Default Settings

Table 6-3 lists the factory defaults for the TimeHub 5500 Output Driver card.

Table 6-3. DS1 and E1 Output Module Default Settings

Setting	Factory Default	Range
Enable/Disable Outputs	Disabled	Settable for each output port
Framing	<ul style="list-style-type: none"> ■ N (prior to firmware version 4236B) ■ Y (firmware version 4236B and higher) 	Y (ESF) / N (D4)
Output Quality Level	9	1 to 9

User Changes to Factory Defaults

Use [Table 6-4](#) to record any changes you make to the factory default settings.

Table 6-4. User Changes to Factory Default Settings

Setting	Factory Default	User Changes
Management Card Defaults		
Security	Off	
Unit Name	TimeHub	
User List configurations	Maximum of 25 users	
EIA-232-C Port	9600 baud Echo = Y	
Ethernet IP Address	IP Address 0.0.0.1 Gateway Address 0.0.0.1 Network Mask 255.255.248.0	
Inactivity Time	100 sec	
Clock Card Defaults		
Bridged Mode	N	
CC Delay	0 ns	
Freerun Action	<ul style="list-style-type: none"> ■ Continue (Master) ■ Squelch (Remote) 	
Holdover and Freerun Quality Level	<ul style="list-style-type: none"> ■ 3 (Primary) ■ 5 (Secondary) 	
Input Enable	<ul style="list-style-type: none"> ■ Y (1 to 4) ■ N (5 to 8) 	
Input Framing	ESF = Y	
Input Priority	<ul style="list-style-type: none"> ■ Input no. +1 (prior to firmware version 4263B) ■ PRS: 1 Others: 2 Remote: 2 (firmware version 4263B and later) 	
Input Selection Mode	Auto	
Main Clock	Master = Y	
Measurement Delay	0 sec	

Table 6-4. User Changes to Factory Default Settings (Continued)

Setting	Factory Default	User Changes
Output Connector Card type	Don't Care	
PRC Frequency	N	
Pull-in Range	<ul style="list-style-type: none"> ■ 16 (Primary Oscillator) ■ 4600 (Secondary Oscillator) 	
Quality Cutoff (Read Input SSM enabled)	3	
Quality Level (Read Input SSM disabled)	<ul style="list-style-type: none"> ■ 1 (PRS) ■ 2 (Inputs 1 –4) 	
Read Input SSM Bits	N	
Sync Mode	Auto	
Time Constant (primary clock)	768	
Time Constant (secondary clock)	384	
Wait Time to restore Sync source	30 sec	
Output Driver Module Defaults		
Enable/Disable Outputs	Disabled	
Framing	<ul style="list-style-type: none"> ■ N (prior to firmware version 4236B) ■ Y (firmware version 4236B and higher) 	
Output Quality Level	9	

Index

A

- A (Active) LED 168
- Active LED 168
- address, setting for Expansion shelf 92
- Alarm Cutoff pushbutton 89
- Alarm LED 165, 173, 178
- alarms
 - clearing false port 159
 - clearing port 158
 - connecting external 91
 - connecting office 90
 - cutoff pushbutton 89
 - external inputs 91
 - false port 158
 - overview 25, 26
 - single clock, disabling 139
 - troubleshooting 179
- audible alarms
 - connecting 90
 - LED 180
 - overview 26
 - pushbutton 181
- automatic reference switching 28

B

- blank panels
 - installing 80
 - part numbers 61
- block diagram, Master shelf 22
- bridging
 - enabling via TimeScan THC 127
 - enabling via TL1 commands 131

C

- cable
 - communications 89
 - compensation, CC 148–150
 - connecting wire-wrap panels 82
 - delay, setting via TimeScan THC 149
 - delay, setting, via TL1 commands 150
 - Ethernet requirements 114
 - Expansion shelf 60, 95
 - null-modem 89, 114
 - Output Connector modules 37, 60
- Cable Management kit, installing 68
- card replacement
 - Clock card 185
 - EC card 187
 - Management card 186
 - Output Driver card 186
- cautions defined 17
- CC LED 175

- checklist, installation 66
- clearing false port alarms 159
- clearing port alarms 158
- Clock card
 - default settings 212
 - freerun mode 29
 - front panel 164
 - fuse, replacing 188
 - holdover mode 29
 - installing 108
 - kit, part number 59
 - overview 24
 - redundancy in Expansion shelves 38
 - replacing 185
 - troubleshooting 164–169
 - use with expansion shelf 35
 - using only one card in a shelf 139
- Comm Port LED 181
- command security levels, defined 151
- communications
 - between Master and Expansion shelves 39
 - configuring via TimeScan THC 116–117
 - configuring via TL1 commands 118–120
 - default parameters 89
 - default port assignments 113
 - serial cable 89
 - software 62
- communications port
 - assignments 113
 - defined 113
- Composite Clock input
 - connecting 88
 - overview 32
 - setting priority via TimeScan THC 138
 - setting priority via TL1 command 139
- Composite Clock output
 - adjusting to CC input 147
 - connecting 82
 - delay, setting 148–150
 - overview 25
- computer 62
 - connecting 89
- connection panels
 - installing 68
 - overview 25
- connections
 - alarms 89
 - communications 88
 - Composite Clock input 88
 - DS1 input 86
 - frame ground
 - Expansion shelf 92
 - Main shelf 73
 - wire-wrap panel 75
- outputs 82

- power
 - Expansion shelf [92](#)
 - Master/Remote shelf [75](#)
- PRS input [87](#)
- wire-wrap panel [82](#)
- covering unused slots [80](#)
- Cutoff LED [180](#)
- Cutoff pushbutton [181](#)

D

- date
 - setting via TimeScan THC [122](#)
 - setting via TL1 commands [122](#)
- default setting, IP addresses [212](#), [214](#)
- default settings
 - Clock cards [212](#)
 - Management card [211](#)
 - Output Driver card [213](#)
- delay, setting CC cable [148–150](#)
- digital multimeter [62](#)
- documentation, related [18](#)
- DS1 inputs
 - connecting [86](#)
 - monitoring [87](#)
 - overview [23](#)
 - setting bridging mode [131](#)
- DS1 LED [175](#)
- DS1 output
 - adjusting [147](#)
 - connecting [82](#)
 - framing
 - setting via TimeScan THC [143](#)
 - setting via TL1 commands [145](#)
 - overview [25](#)
- dual-channel oscilloscope [62](#)

E

- E (Enabled) LED [167](#)
- electromagnetic interference considerations [65](#)
- EMI considerations [65](#)
- ESD wrist strap [62](#)
- Ethernet port
 - assignment [113](#)
 - cable requirements [114](#)
 - configuring via TimeScan THC [116–117](#)
 - configuring via TL1 commands [118–120](#)
 - connecting via Telnet [120](#)
 - logging in to TimeScan THC [120](#)
 - number, assigning via TimeScan THC [116](#)
 - number, assigning via TL1 commands [119](#)
 - overview [23](#)
 - protocol [113](#)
- Expansion Controller card
 - front panel [182](#)
 - installing [112](#)
 - kit, part number [60](#)
 - overview [36](#), [56](#)

- redundancy [39](#)
- replacing [187](#)
- troubleshooting [182](#)
- expansion link
 - installing [95](#)
 - testing [112](#)
 - to Expansion shelf [37](#)
- Expansion Link LED [184](#)
- Expansion shelf
 - blank panel part number [61](#)
 - Clock cards [44](#)
 - Clock cards required [35](#)
 - communicating with the Master shelf [39](#)
 - connecting multiple [95](#)
 - connecting single [95](#)
 - installing [92](#)
 - kit, part number [60](#)
 - Output Connector modules [38](#), [54](#)
 - overview [35](#)
 - setting the address [92](#)
- external alarms, connecting [91](#)

F

- factory default
 - enabling [155](#)
 - values [211–213](#)
- Fail LED [165](#), [174](#), [178](#), [183](#)
- false port alarms [158](#)
- Fast Track LED [166](#)
- firmware version, retrieving from Output Driver card [175](#)
- Force Active button [169](#), [185](#)
- Frame ground connections [73](#)
- framing
 - DS1 outputs
 - setting via TimeScan THC [143](#)
 - setting via via TL1 commands [145](#)
 - inputs
 - setting via TimeScan THC [127](#)
 - setting via TL1 commands [131](#)
- Freerun LED [166](#)
- Freerun mode
 - overview [29](#)
 - troubleshooting [166](#)
- fuse
 - Clock card, replacing [188](#)
 - Management card, replacing [189](#)
 - Output Driver card, replacing [190](#)
 - source supply [76](#)
- Fuse LED [165](#), [173](#), [178](#), [183](#)

G

- gateway address
 - default [212](#), [214](#)
 - setting via TimeScan THC [116](#)
 - setting via TL1 commands [119](#)
- gender changer, installing [95](#)

Global Services telephone/address [202](#)
GMT fuse puller [62](#), [188](#), [189](#), [191](#)
GPS connector [91](#)
grounding
 Expansion shelf [92](#)
 Main shelf [73](#)
 wire-wrap panel [75](#)

H

Holdover LED [167](#)
Holdover mode [22](#)
 troubleshooting [167](#)

I

input reference switching [28](#)
Input/Alarm Connector module
 installing [78](#)
 overview [23](#)
inputs
 Composite Clock [88](#)
 DS1 reference [86](#)
 enabling SSM via TimeScan THC [127](#)
 enabling SSM via TL1 commands [131](#)
 enabling via TL1 commands [129](#)
 external alarm [91](#)
 Master shelf, provisioning [125–132](#)
 monitoring DS1 [87](#)
 monitoring, selecting via TimeScan THC [126](#)
 monitoring, selecting via TL1 commands [130](#)
 overview [20](#), [23](#)
 provisioning via TimeScan THC [125–128](#)
 provisioning via TL1 commands [128–132](#)
 PRS [87](#)
 Remote shelf, provisioning [136–139](#)
 SSM overview [27](#)
installation
 checklist [66](#)
 EMI considerations [65](#)
 preliminary procedures [64](#)
 tools and equipment [65](#)
installing
 blank panels [80](#)
 Clock card [108](#)
 Expansion Controller card [112](#)
 Input/Alarm Connector module [78](#)
 Management card [105](#)
 Output Connector modules [78](#)
 Output Driver cards in Expansion shelf [113](#)
 Output Driver cards in Master shelf [111](#)
interference, electromagnetic [65](#)
IP address
 default [212](#), [214](#)
 setting via TimeScan THC [116](#)
 setting via TL1 command [118](#)

L

LAN connection [88](#)
LAN port, see Ethernet port
laptop computer [62](#)
LEDs
 A (Active) [168](#)
 Active [168](#)
 Alarm [165](#), [173](#), [178](#)
 CC [175](#)
 Clock cards [46](#)
 Comm Port [181](#)
 Cutoff [180](#)
 DS1 [175](#)
 E (Enabled) [167](#)
 Expansion Controller card [58](#)
 Expansion Link [184](#)
 Fail [165](#), [174](#), [178](#), [183](#)
 Fast Track [166](#)
 Freerun [166](#)
 Fuse [165](#), [173](#), [178](#), [183](#)
 Holdover [167](#)
 Local Logon [181](#)
 Local Xmit [181](#)
 Passthrough [181](#)
 Power [165](#), [173](#), [178](#), [183](#)
 Q (Qualified) [168](#)
 Remote Link [181](#)
 Remote Logon [181](#)
 Remote Xmit [181](#)
 Shelf Alarm [183](#)
 Shelf Critical [180](#)
 Shelf Major [180](#)
 Shelf Minor [180](#)
 Shelf Power [178](#), [183](#)
 SmartClock [167](#)
 Standby [169](#)
 System Critical [179](#)
 System Major [179](#)
 System Minor [179](#)
 Tracking [166](#)
 Warmup [166](#)
link cable
 installing [95](#)
 redundancy [39](#)
 testing [112](#)
Local comms connector [88](#)
Local Logon LED [181](#)
Local port
 connecting [88](#)
 default values [89](#), [212](#), [214](#)
 overview [23](#)
Local Xmit LED [181](#)
logging in
 TimeScan via Ethernet [120](#)
 TimeScan via serial port [114](#)
 via local port [115](#)

M

Management card

- default settings [211](#)
- enabling security [152](#)
- front panel [177](#)
- installing [105](#)
- kit, part number [59](#)
- overview [24](#)
- replacing [186](#)
- replacing the fuse [189](#)
- troubleshooting [177–181](#)

mask IP address

- default [212](#), [214](#)
- setting via TimeScan THC [116](#)
- setting via TL1 commands [118](#)

Master mode, setting [72](#)

Master shelf

- blank panel part number [60](#)
- block diagram [22](#)
- Clock cards [44](#)
- communicating with an Expansion shelf [39](#)
- installing [67](#)
- kit, part number [59](#)
- Output Connector modules [54](#)
- overview [20](#), [32](#)
- provisioning inputs [125–132](#)
- rear panel [77](#)
- setting mode [72](#)

monitoring inputs

- selecting via TimeScan THC [126](#)
- selecting via TL1 commands [130](#)

monitoring inputs, DS1 [87](#)

mounting ears, rack [67](#)

multimeter, digital [62](#)

N

notes defined [17](#)

null-modem cable [89](#), [114](#)

O

office alarms, connecting [90](#)

oscilloscope, dual-channel [62](#)

Output Connector modules

- and Output Driver cards [38](#)
- cable [37](#)
- Expansion shelf [37](#), [54](#)
- installing [78](#)
- Master shelf [54](#)
- overview [25](#)

Output Driver card

- and Output Connector modules [38](#)
- default settings [213](#)
- firmware version, retrieving [175](#)
- front panel [172](#)
- installing in Expansion shelf [113](#)

installing in Master shelf [111](#)

kit, part number [60](#)

overview [25](#)

redundancy [39](#)

replacing [186](#)

replacing the fuse [190](#)

troubleshooting [172–175](#)

use in expansion shelf [36](#)

outputs

CC, adjusting [146–150](#)

DS1, adjusting [147](#)

enabling via TimeScan THC [143](#)

enabling via TL1 command [146](#)

provisioning via TimeScan THC [142–144](#)

provisioning via TL1 commands [144–146](#)

SSM overview [28](#)

P

packaging for shipment [201](#)

part numbers [59–62](#)

Passthrough LED [181](#)

passthrough mode [22](#), [29–32](#)

password [152](#)

changing [154](#)

creating [153](#)

phase-aligning CC outputs [147](#)

Phillips-head screwdriver [62](#)

pin-out

LAN connector [88](#)

local port [89](#)

power

Expansion shelf [92](#)

Master/Remote shelf [75](#)

testing connections [76](#)

Power LED [165](#), [173](#), [178](#), [183](#)

power supply

fuse [76](#)

overview [23](#)

Pozidrive screwdriver [62](#)

priority level

setting via TimeScan THC [127](#)

setting via TL1 commands [130](#)

priority level, effect on switching [28](#)

provisioning

inputs

via TimeScan THC [125–128](#)

via TL1 commands [128–132](#)

outputs

via TimeScan THC [142–144](#)

via TL1 commands [144–146](#)

PRS input

connecting [87](#)

overview [23](#)

setting frequency via TimeScan THC [127](#)

setting frequency via TL1 commands [129](#)

purpose of this guide [14](#)

Q

- Q (Qualified) LED [168](#)
- quality level
 - effect on switching [28](#)
 - SSM, overview [27](#)
- quartz Clock cards [44](#)

R

- rack mounting
 - Expansion shelf [92](#)
 - Master shelf [67](#)
 - space required [64](#)
- rear panel
 - Master shelf [77](#)
- recommendations defined [17](#)
- redundancy
 - Clock cards [24, 38](#)
 - Master-Expansion shelf [38](#)
 - Output Driver cards [36, 39](#)
 - power [23, 37](#)
- reference input
 - Composite Clock [88](#)
 - DS1 [86](#)
 - PRS [87](#)
- reference switching
 - overview [28](#)
 - testing [161](#)
- related documentation [18](#)
- Remote Link LED [181](#)
- Remote Logon LED [181](#)
- Remote mode, setting [72](#)
- Remote shelf
 - Composite Clock inputs [88](#)
 - inputs [34](#)
 - locating [33](#)
 - overview [32](#)
 - provisioning inputs [136–139](#)
 - setting mode [72](#)
 - SSMs [34](#)
- Remote Xmit LED [181](#)
- replacing the Clock card [185](#)
- replacing the EC card [187](#)
- replacing the Management card [186](#)
- replacing the Output driver card [186](#)
- return material authorization [202](#)
- returning products to factory, procedure [201](#)
- RMA. see return material authorization
- RS-232 connection [88](#)
- rubidium Clock cards [44](#)

S

- screwdriver, Phillips-head [62](#)
- security
 - command-level, defined [151](#)
 - enabling [151](#)

- location of Security switch [106](#)
- overview [151](#)
- user levels defined [151](#)
- serial port
 - assignment [113](#)
 - logging in to TimeScan THC [114](#)
 - protocol [113](#)
- setting Master/Remote mode [72](#)
- Shelf Alarm LED [183](#)
- Shelf Critical LED [180](#)
- Shelf Major LED [180](#)
- Shelf Minor LED [180](#)
- Shelf Power LED [178, 183](#)
- shipping address, repair [202](#)
- shipping products to factory, procedure [201](#)
- SID, setting [122](#)
- single Clock card [139](#)
- site survey [64](#)
- SmartClock LED [167](#)
- software, TimeScan THC [62](#)
- space required in rack [64](#)
- spare parts, part numbers [61](#)
- SSM
 - input
 - enable via TL1 commands [131](#)
 - enabling SSM via TimeScan THC [127](#)
 - overview [27](#)
 - output overview [28](#)
 - overview [27](#)
 - quality level overview [27](#)
 - reference switching [28](#)
 - remote shelf [34](#)
- Standby LED [169](#)
- structure of this guide [15](#)
- subnet mask
 - setting via TimeScan THC [116](#)
 - setting via TL1 commands [118](#)
- Symmetricom
 - Global Services address [202](#)
- Synchronization Status Messaging. see SSM
- System Critical LED [179](#)
- system ID, setting [122](#)
- System Major LED [179](#)
- System Minor LED [179](#)

T

- target ID, setting [123](#)
- telephone contact numbers [202](#)
- Telnet, connecting to Ethernet port via [120](#)
- termination connector
 - installing on multiple Expansion shelves [96](#)
 - installing on single Expansion shelf [95](#)
- testing
 - clock input signals [140](#)
 - expansion links [112](#)
 - power connections [76](#)
 - reference switching [161](#)
- TID, setting [123](#)

time
 setting via TimeScan THC [122](#)
 setting via TL1 commands [122](#)
TimeScan THC software [62](#)
 logging in via Ethernet [120](#)
 logging in via serial port [114](#)
timing offset, CC [148–150](#)
tools and equipment, installation [65](#)
Tracking LED [166](#)
troubleshooting
 Clock card [164–169](#)
 Expansion Controller card [182](#)
 expansion links [184](#)
 Freerun mode [166](#)
 Holdover mode [167](#)
 Management card [177–181](#)
 Output Driver card [172–175](#)

U

unpacking and inspection [67](#)
unused slots, covering [80](#)
user
 deleting [154, 155](#)

 managing via TimeScan THC [153](#)
 managing via TL1 commands [154](#)
user changes to default settings [214](#)
user security levels, defined [151](#)

V

ventilation precautions, considerations [66](#)
visible alarms
 connecting [90](#)
 overview [26](#)

W

Warmup LED [166](#)
warnings defined [17](#)
web address [18](#)
wire-wrap panel
 cables [37](#)
 connecting [82](#)
 installing [68](#)
 part numbers [61](#)
wrist strap, ESD [62](#)